

Our universal safety relays offer various input options for use with many different safety devices and risk levels

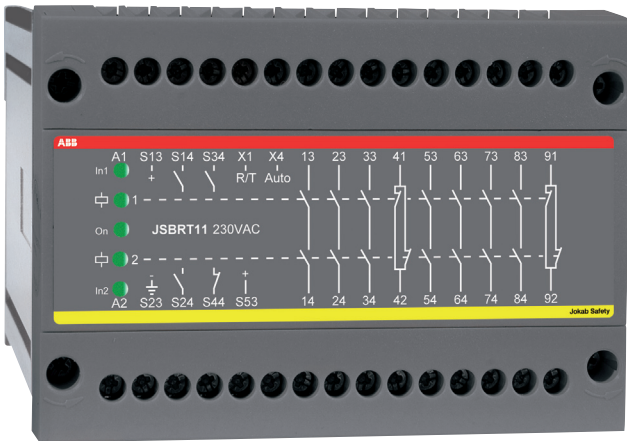

Safety Relays

Meet existing safety standards!
Supervise safety devices!
Safe stops and reliable restarts!

Why should I use Safety Relays? 5:2

The Smallest and Most Flexible Safety Relays on the Market 5:3

Creating a Control Reliable Safety System 5:4

Safety Relays Summary 5:6

Safety Relays - RT Series

- RT6..... 5:8
- RT7..... 5:12
- RT9..... 5:16
- JSBRT11 5:20

Safety Relays - JSB Series

- JSBR4 5:22
- JSBT4..... 5:24
- BT50/BT50T 5:26
- BT51/BT51T 5:28
- JSBT5(T)..... 5:30

Safety Timers

- JSHT1 A/B 5:32
- JSHT2 A/B/C 5:34

Expansion Relays

- E1T 5:36
- JSR1T..... 5:38
- JSR2A 5:40
- JSR3T..... 5:42

Connection Examples 5:44

Component List and Ordering Information 5:62

Why should I use Safety Relays?

...to meet existing safety standards!

“A fault in the hardware or the software of the control system must not lead to hazardous situations.” This is the requirement in the EU’s Machinery Directive 2006/42/EG under the heading 1.2.1 “Safety and reliability of control systems”. The directive implies that no person should be put at risk if for example, a relay sticks or if a transistor or two electrical conductors short-circuit.

A safety relay will fulfill these requirements. A safety relay has, for example, inputs that are checked for short-circuits and dual redundant circuits that are checked at each operation. This can be compared to the dual brake circuits in a car. If one of the circuits is faulty the other will stop the car. In a safety relay there is an additional function which only allows a machine to start if both circuits are ok.

The safety standard describes various safety categories depending on the level of risk and application. One single universal relay with selectable safety categories solves this.

...for safe stops and reliable restarts!



Dual stop signals when the gate is opened...

Entering or putting a hand or limb into a hazardous area, must cause all machines that can cause a personal injury to stop safely. Many serious accidents occur when machinery is believed to have stopped but is in fact only pausing in its program sequence. The safety relay monitors the gate interlock switch, the cables and gives dual stop signals.



Supervised reset when there can be a person within the risk area...

Make sure that nobody is within the restricted area when activating the reset button. A supervised reset button must be pressed and released before a reset can occur. Many serious accidents have been caused by an unintentional and unsupervised reset.



Timed reset when you cannot see the entire risk area...

Sometimes a double reset function is necessary to make sure that no one is left behind in the risk area. First, after ensuring no other person is inside the hazardous area, the pre-reset button must be activated, followed by the reset button outside the risk area within an acceptable time period e.g. 10 seconds. A safety timer and a safety relay can provide this function.



Automatic reset for small hatches...

Where body entry is not possible through a hatch, the safety circuit can be automatically reset.

The safety relays are reset immediately when the hatch interlock switch contacts are closed.

...to supervise safety devices!



Light Beams

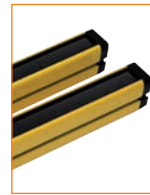

Light Curtains



3-Position Devices



2-Hand Devices



Safety Interlock Switches



Emergency Stop Buttons



Safety Strips and Bumpers

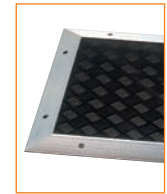

Safety Guard Mats

The Smallest and Most Flexible Safety Relays on the Market!

We have the most flexible safety relays on the market. Our first universal relay was developed nearly 20 years ago. Today the flexibility is even greater and the size has been reduced by 85%.

A universal relay is a safety relay with various input options for various safety devices and risk levels. Internally, the safety relay is of the highest safety level (category 4 according to EN 954-1/EN ISO 13849-1). A machine supplier can therefore, with one single safety relay, select the input configuration that best suits his customer's safety requirements. In addition, our safety relays have detachable connector blocks for ease of replacement and testing.

As our universal relay incorporates all input options, it is compatible with all our previous safety relays as well as with other manufacturers products.

Is a universal relay expensive? No, our latest patented construction is extremely simple and the number of major components is less compared to our previous universal relays. This means that our safety relays are even more reliable and economical than before.

We also have gained a great deal of experience from creating safety solutions for our own systems. It would be our pleasure to share these experiences with you! Please do not hesitate to contact us if you should require any other safety solutions.

Inputs for various safety devices

Input for manual or automatic resetting

RT7: The most flexible Safety Relay on the market!

Detachable connector blocks

Outputs for program stop, gate opened or closed and reset indication

Safety outputs for immediate and delayed stops at optional times

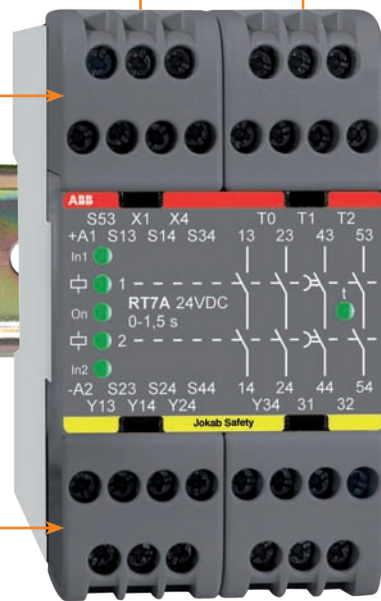

Some of the advantages with JOKAB SAFETY's Safety Relays...

- Universal relays
- Excellent reliability
- Approved in Europe, USA, Canada
- Supervised reset
- Time reset
- Small and compact
- Detachable connector blocks
- Low power consumption
- Permits the use of long runs of cables
- Functions set by external hardwired links
- LED indication and outputs for indication
- Powerful switching capacity

Creating a Control Reliable Safety System

Where required by the appropriate ANSI standard (example clause 4.5.4 of RIA 15.06.1999), the importance of using safety relays to achieve control reliable circuits can be explained. Control Reliable Systems

must be designed “such that a single component failure within the system does not prevent the stopping action from taking place but will prevent successive system cycle until that failure has been corrected.”

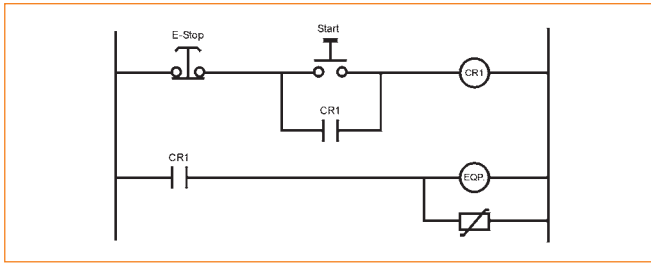

Ladder Diagram of a Common Emergency Stop Circuit

In this typical emergency stop circuit the weakest link is relay CR1. The contacts of CR1 can weld closed or, since this relay is spring applied, it can fail mechanically. If this failure occurred, energy to the load would continue resulting in an UNSAFE CONDITION that would cause machine damage and/or personnel injury. ANSI standards and OSHA regulations demand prevention of such a condition.

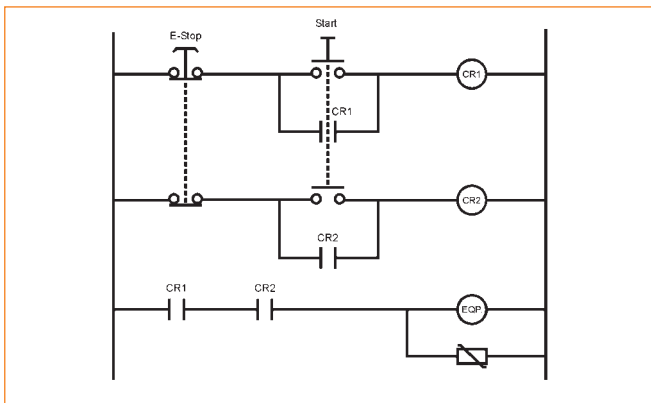

Ladder Diagram using two Force-Guided Relays to Achieve Redundancy

According to the definition of control reliability we need to guard against failure of CR1. It is one source for a single component failure. Redundancy is not sufficient. If one of the two relays fail you are back to square one — with redundancy lost, the second relay could fail on a subsequent machine cycle.

We must monitor the condition of the redundant relays. Force or positive guided relays provide the best solution to accomplish monitoring.

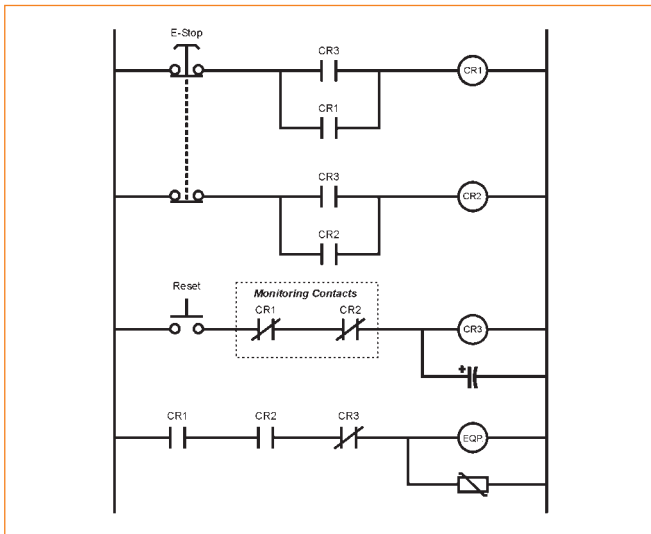

Ladder Diagram of a Circuit using three Force-Guided Relays

This circuit is approaching control reliable. Using positive guided relays offers redundancy and cross-monitoring, but does not monitor for short circuits or reset problems.

Note: Safety Category only refers to the safety relay configuration, input devices, output devices and wiring must be considered for a safety category of the system.

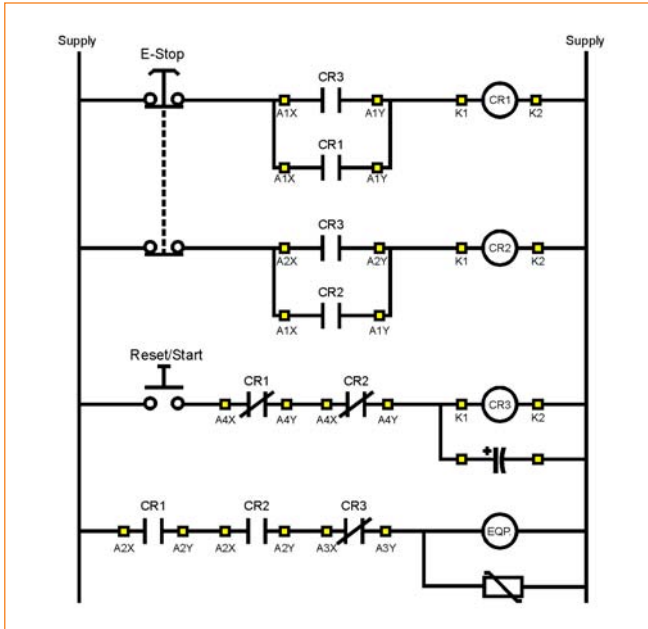

Ladder Diagram using three Force-Guided Relays

Advantages

- Has redundancy and cross-monitoring

Disadvantages (in comparison to the Jokab Safety Relay)

- No safety approvals
- 38 wiring points
- High chance of wiring errors
- Installation is labor intensive
- More costly
- Larger in overall size (panel space)
- Easy to tamper with and bypass connections
- No short circuit protection on the inputs
- Reset is not monitored
- Difficult to troubleshoot
- The more contacts needed, the more complicated the circuit.

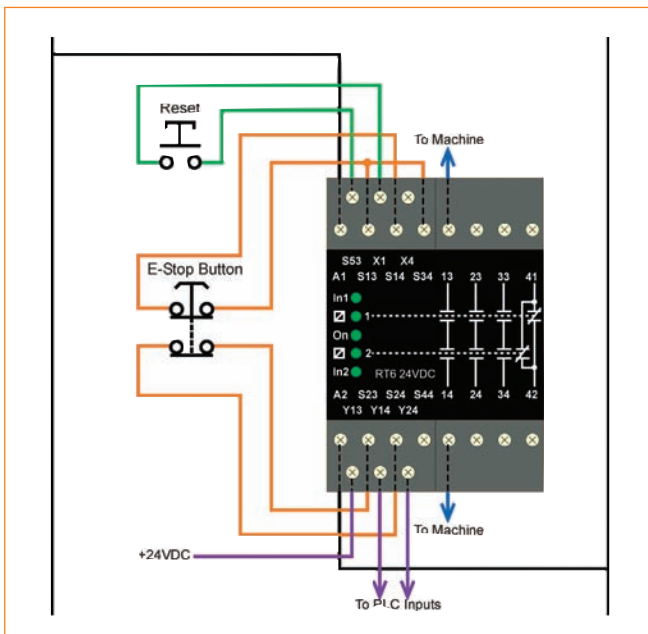

Wiring Diagram using a RT6 Jokab Safety Relay connected in Input Configuration Mode 4 to Achieve Control Reliability Electrically

Advantages (in comparison to the 3 Force-Guided Relays Circuit)

- Control reliable electrically
- Has redundancy and cross-monitoring
- 4 input configuration modes which are hardwire selectable (selectable category of safety)
- 2 reset configuration modes which are hardwire selectable
- Manual supervised reset mode monitors the button and wiring against failure
- Input configuration modes 3 and 4 monitor all input devices and wiring against failure
- Monitors external positive or force-guided contactors/relays
- Universal (multi-purpose)
- Retrofits easily into existing systems
- 5 LED indicators: Power On, Input 1, Input 2, Output K1 and Output K2
- 3 NO safety outputs, 1 NC monitoring output
- 2 transistor outputs for input status and output status
- Available in a variety of source voltages
- Terminal strips are removable for easy change
- 17 wiring points
- Cost effective
- Compact in size (45 mm in width)
- Several safety approvals

Note: Safety Category only refers to the safety relay configuration, input devices, output devices and wiring must be considered for a safety category of the system.

Safety Relays Summary

Which Safety Relay should you choose?

First of all, we recommend the selection of one of our latest universal relays in the RT-series. These are both practical and cost effective. To facilitate the choice of safety relay or combinations of safety relays, please see:

- the table below dividing the safety relays into application fields
- the table on the opposite page showing possible input and output options

- the relevant data sheet giving comprehensive information about each specific safety relay
- the circuit diagram for various applications are located in "Connection Examples" beginning on page 5:44

Note: All earlier type of relays that can now be replaced by those in this manual are still kept as stock items and can be supplied upon request.

Application Fields

	Safety Relays									Safety Timers		Expansion Relays			
	RT6	RT7	RT9	JSBRT11	JSBR4	JSBT4	JSBT5T/BT50T/BT51T	JSBT5/BT50/BT51	JSH11A/B	JSH2A/B/C	E1T	JSR1T	JSR2A	JSR3T	
Interlocking Switch/Gate/Hatch	•	•	•	•	•	•	•	•							
Light Curtains	•	•	•	•											
Light Beams	•	•	•	•											
Safety Mats	•	•	•		•	•									
Contact Strips	•	•	•		•	•									
Two-Hand Control Device					•										
Emergency Stop	•	•	•	•	•	•	•	•							
Hold to Run/Enabling Device	•	•	•	•	•	•				•					
Foot Control Device	•	•	•	•	•	•				•					
Area Supervision	•	•	•	•	•	•									
Time Resetting									•						
Time Bypassing									•	•					
Inching										•					
Output Expansion	•	•	•	•		•	•	•			•	•	•		
Delayed Output		•					•				•	•		•	

Input Alternatives

Single-Channel,
1 NO from +24V
Safety Category 1



The input must be closed before the outputs can be activated. A stop signal is given when the input is opened.

Two-channel,
2 NO from +24V
Safety Category 3

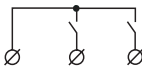

Both the inputs must be closed before the outputs can be activated. A stop signal is given if one or both of the inputs are opened. Both the inputs must be opened and reclosed before the outputs can be reactivated. A short-circuit between the inputs is not monitored by the safety relay. Category 4 can only be achieved if a safety device with short circuit monitored outputs is connected.

Two-Channel,
1 NO & 1 NC
from +24 V
Safety Category 4

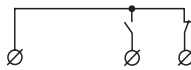

One input must be closed and one must be opened before the outputs can be activated. A stop signal is given if one or both of the inputs change position or if the inputs short-circuit. Both inputs must be put into their initial position before the outputs can be reactivated.

Two-Channel,
1 NO from 0 V &
1 NO from +24 V
Safety Category 4

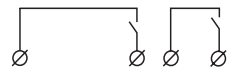

Both the inputs must be closed before the outputs can be activated. A stop signal is given if one or both of the inputs are opened. Both the inputs must be opened and reclosed before the outputs can be reactivated. Stop signal is given if there is a short-circuit between the inputs.

Technical Data

- * indicates the possibility of selecting delayed outputs
- indicates one relay contact per output (other relays having two contacts per output)
- ‡ delayed
- category 4 depending on connection (when used as expansion relay with Pluto Safety PLC, then category 4)
- † fixed 0.5 s delay

	Safety Relays											Safety Timers		Expansion Relays			
	RT6	RT7	RT9	JSBRT11	JSBR4	JSBT4	JSBT5T	BT50T	BT51T	BT50	BT51	JSHT1A/B	JSHT2A/B/C	E1T	JSR1T	JSR2A	JSR3T
Safety Category	1-4	1-4	1-4	1-4	4	4	1-4 [◦]	1-4 [◦]	1-4 [◦]	1-4 [◦]	1-4 [◦]	1-4	1-4	1-4	1-4	1-4	1-4
Safety Input																	
Single-Channel, 1 NO from +24 V	●	●	●	●			●	●	●	●	●	●	●	●	●	●	●
Two-Channel, 2 NO from +24 V	●	●	●	●													
Two-Channel, 1 NO & 1 NC from +24 V	●	●	●	●													
Two-Channel, 1 NO from 0 V & 1 NO from + 24 V	●	●	●	●	●	●						●	●	●	●	●	●
Contact Strips/Safety Mats	●	●	●		●	●											
Reset & Test Input																	
Monitored Manual	●	●	●	●	●												
Automatic/Unmonitored Manual	●	●	●	●		●	●	●	●	●	●	●	●				
Testing of Contactors, Relays, Valves, etc.	●	●	●	●	●	●	●	●	●	●	●	●	●				
Output																	
NO	3	2	2	7	3	3					3	4			4*	4*	4
NO Delayed		2					3†	3	4						4*	4*	2□
NO Impulse Outputs													2□	2□			
NC	1	1		2	1	1					1				1*	1	
NC Delayed							1†	1							1*		
Information Output	2	3	1						1	1							
Switching Capacity (Resistive Load)																	
6A/250VAC/1500VA/150W	4	3	2	9	4	4	4	4‡	4‡	4	4				4	5	
4A/250VAC/1000VA/100W												2□	2□				2□
6A/250VAC/1380VA/138W		2‡															
10A/250VAC/1840VA/192W																	5
Width (mm)	45	45	22.5	100	45	45	22.5	22.5	22.5	22.5	22.5	45	45	22.5	45	45	22.5
Supply Voltage																	
12VDC							●										
24VDC	●	●	●	●	●	●	●	●	●	●	●	●	●	●	●	●	●
24VAC	●	●		●	●	●	●					●	●			●	●
48VAC	●	●		●	●	●						●	●			●	
115VAC	●	●		●	●	●						●	●			●	
230VAC	●	●		●	●	●						●	●			●	

Contact strips/
Safety Mats
Category 3,
up to PL d

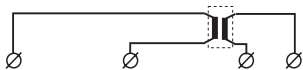

For an unpressurized mat/strip, both the relay inputs must be closed for the outputs to be activated. In the case of an activated mat/strip and short-circuit input channels, the relay will be de-energized. Current limitation prevents the safety relay from being overloaded when the channels short-circuit.

Monitored
Manual Reset



A monitored reset means that the safety relay will not be reset if the reset button gets jammed when pressed in or if the input short-circuits. In order for the resetting to be complete, the input must be closed and opened before the outputs can close.

Automatic/
Unmonitored
Manual
Reset



Automatic reset means that the outputs are closed immediately when both the input conditions are satisfied and the test input is closed.

Testing of
Contactors,
Relays
and Valves

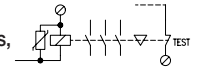

Can be carried out with both automatic and manual reset.

Note: If serial contacts are connected to the input, the Safety Category is made lower for two-channel connections. Safety Category only refers to the safety relay configuration. Input devices, output devices and wiring must be considered for a safety category of the system.

RT6 Safety Relay

Would you like a single safety relay for all your safety applications?

Then choose the RT6 universal relay to supervise both your safety devices and the internal safety of your machinery. In addition you can select the safety level required for each installation. All this is possible because the RT6 has the most versatile input option arrangement available on the market. Many other relays can therefore be replaced by the RT6.

The relay also comes with other options such as manual or automatic reset. Manual supervised reset can be used for gates and other safety devices that can be passed through. Automatic reset can be used for small hatches, if deemed acceptable from a risk assessment.

The RT6 also has information outputs that follow the inputs and outputs of the relay. These outputs will for example indicate if a gate is open or closed and if the safety relay needs to be reset.

The RT6 is designed with a minimum amount of components thus keeping both production costs and component acquisitions to a minimum.

Choose the RT6 to simplify your safety circuits and reduce your costs.

Connection Examples

For examples of how our safety relays can solve various safety problems, see “Connection Examples” beginning on page 5:44.

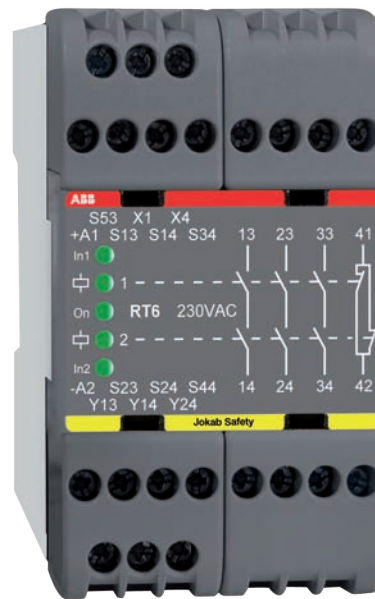

Applications

- Emergency Stops
- Light Curtains
- Three Position Devices
- Interlocked Gates/Hatches
- Magnetic Switches
- Light Beams
- Safety Mats
- Contact Strips
- Foot-Operated Switches

Features

- Five input options
- Single or dual channel input
- Manual supervised or automatic reset
- Test input for supervision of external contactors
- Width 45 mm
- LED indication of supply, inputs, outputs, short-circuit and low voltage level
- 3 NO/1 NC relay outputs
- Two voltage free transistor information outputs
- 24 VDC
- 24, 48, 115 or 230 VAC
- Quick release connector blocks

Approvals



RT6 Technical Information

Inputs

The RT6 can be configured to operate in either of the following input options:

1. Single channel, 1 NO contact from +24 V DC, safety category 1.
2. Dual channel, 2 NO contacts from +24 V DC, safety category 3.
3. Dual channel 1 NO, 1 NC contact from +24 V DC, safety category 4.
4. Dual channel, 1 NO contact from 0V and 1 NO contact from +24 V DC, safety category 4.
5. Safety mats/contact strips 1 'contact' from 0V and 1 'contact' from +24 V DC, safety category 1.

Note: Safety category only refers to the safety relay configuration, input devices, output devices and wiring must be considered for a safety category of the system.

When the input/inputs are activated and the test/supervised reset is complete, relays 1 and 2 are energized. These are de-energized when the input/inputs are de-activated in accordance with the input option chosen or in case of a power failure. Relays 1 and 2 must both be de-energized before the RT6 can be reset.

Transistor Output Status Information

The RT6 has two voltage free transistor outputs that can be connected to a PLC, computer or other monitoring device. These outputs give the input and output status of the relay.

Reset and Testing

The RT6 has two reset options; manual and automatic. The manual supervised reset is used when the RT6 is monitoring safety devices that can be passed through, i.e. to ensure that the outputs of the safety relay do not close just because a gate is closed. The automatic reset should only be used if deemed an acceptable risk.

In addition, the RT6 can also test (supervise), if for example, contactors and valves etc. are de-energized/de-activated before a restart is allowed.

Indication of Low Voltage

The 'On' LED will flash if the relay supply voltage falls below an acceptable level. This indication will also be given if a monitored safety mat/contact strip is actuated. See connection option 5.

Safety Level

The RT6 has internal dual and supervised safety functions. Power failure, internal faulty component or external interference will not present a risk to options with the highest safety level. A manual reset requires that the reset input is closed and opened before the safety relay outputs are activated. A short-circuit or a faulty reset button is consequently supervised.

When the RT6 is configured for dual channel input, both the inputs are supervised for correct sequence operation before the unit can be reset.

The input options 3 and 4 have the highest safety levels as all short-circuits and power failures are supervised. This in combination with double internal current limitation makes the relay ideal for supervision of safety mats and contact strips.

Regulations and Standards

The RT6 is designed and approved in accordance with appropriate directives and standards. Examples of such are: 98/37/EC, EN ISO 12100-1/-2, EN 60204-1 and EN 954-1/EN ISO 13849-1.

Connection Examples

For examples of how our safety relays can solve various safety problems, see "Connection Examples" beginning on page 5:44.

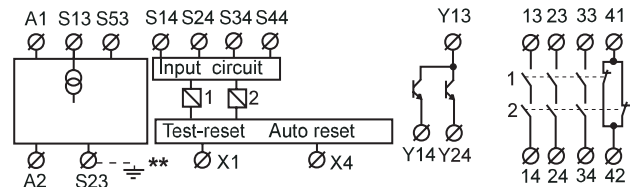

****Only for AC supply**

Connection of Supply DC Supply

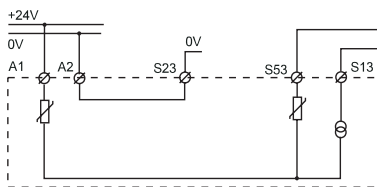

The RT6 DC option should be supplied with +24 V on A1 and 0 V on A2.

AC Supply

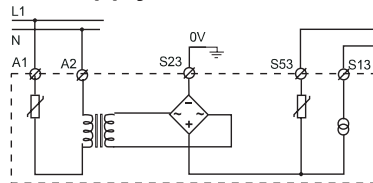

The RT6 AC option should be supplied with the appropriate supply voltage via connections A1 and A2.

The S23/⏏ must be connected to protective earth.

DC Supply of AC Units

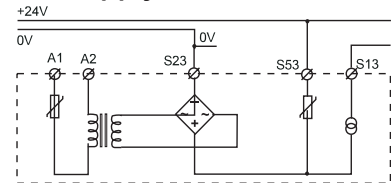

All AC-units can also be supplied by +24 VDC to S53 (0VDC to S23).

Note: With both DC and AC modules, if cable shielding is used this must be connected to an earth rail or an equivalent earth point.

RT6 Connection of Safety Devices

1. Single Channel, 1 NO from +24V



The input (contact to S14) must be closed before the outputs can be activated. When the input contact is opened the relay safety output contacts open.

2. Dual Channel, 2 NO from +24V



Both input contacts (S14 and S34) must be closed before the relay outputs can be activated. The safety relay contacts will open if one or both of the input contacts are opened. Both the input contacts must be opened and reclosed before the relay can be reset. A short-circuit between inputs S14 and S34 can only be supervised if the device connected to the inputs has short-circuit supervised outputs, e.g. Jokab Focus light curtains.

3. Dual Channel, 1 NO, 1 NC from +24V

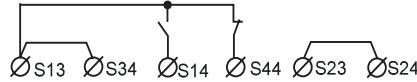

One input contact must be closed (S14) and one opened (S44) before the relay outputs can be activated. The safety relay contacts will open if one or both of the inputs change status or in case of a short-circuit between S14 and S44. Both inputs must return to their initial positions before the relay outputs can be reactivated.

4. Dual Channel, 1 NO from +24V, 1 NO to 0V



Relay functions as option 2, but a short-circuit, in this case between inputs S14 and S24, is supervised (safety outputs are opened).

5. Safety Mat or Contact Strip

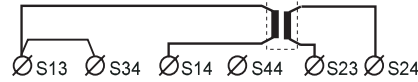

Both 'contact' inputs from an inactivated safety mat/contact strip must be made in order to allow the RT6 relay outputs to be activated. When the safety mat/contact strip is activated or a short-circuit is detected across S14-S23, the relay will de-energize (safety outputs open) and the 'ON' LED will flash. As output S13 has an internal current limit of 80 mA, the RT6 will not be overloaded when the mat/contact strip is activated or a short circuit is detected.

RT6 Reset Connections

Manual Supervised Reset

The manual supervised reset contact connected to input X1 must be closed and opened in order to activate the relay outputs.

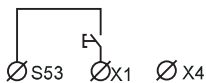

Automatic Reset

Automatic reset is selected when S53, X1 and X4 are linked. The relay outputs are then activated at the same time as the inputs.

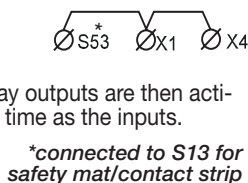

Testing External Contactor Status

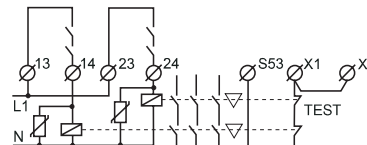

Contactors, relays and valves can be supervised by connecting 'test' contacts between S53 and X1. Both manual supervised and automatic reset can be used.

RT6 Output Connections

Relay Outputs

The RT6 has three (3 NO) safety outputs and 1 NC information output.

In order to protect the RT6 output contacts it is recommended that loads (inductive) are suppressed by fitting correctly chosen VDRs, diodes, etc. Diodes are the best arc suppressors, but will increase the switch off time of the load.

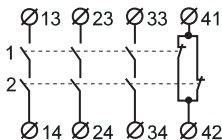

Transistor Outputs

The RT6 has two (2) voltage free transistor information outputs.

The transistor outputs are supplied with voltage to Y13, either from S53 (+24V) or an external 5-30 VDC. Y14 and Y24 follow the relay inputs and outputs as follows:

- Y14 becomes conductive when the relay input conditions are fulfilled.
- Y24 becomes conductive when both the output relays are activated.

***Note: These outputs are only for information purposes and must not be connected to the safety circuits of the machinery.

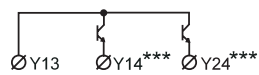

RT6 Technical Data

Manufacturer	ABB AB/Jokab Safety, Sweden
Ordering information	see page 5:62
Color	Grey
Weight	335 g (24 VDC) 485 g (24-230 VAC)
Supply Voltage (A1-A2)	24 VDC +15/-20%, 24/48/115/230 VAC, +15/-10%, 50-60 Hz
Power consumption DC supply, nominal voltage AC supply, nominal voltage	2.3 W 5.2 VA
Connection S13 Short-circuit protected voltage output, 70 mA ± 10% current limitation (Is used for the inputs S14, S34 and S44)	
Connection S53 Short-circuit protected voltage output, internal automatic fuse 270 mA (Is used for the reset and autoreset inputs X1 and X4)	
Connection S23 0V connection for input S24	
Safety inputs S14 (+) input S24 (0V) input S34 (+) input S44 (+) input	20 mA 20 mA 20 mA 30 mA
Reset input X1 Supply for reset input Reset current	+ 24VDC 300 mA current pulse at contact, then 30 mA
Minimum contact closure time for reset	100 ms
Maximum external connection cable resistance at nominal voltage for S14, S24, S34 S44, X1	300 Ohm 150 Ohm
Response time At Power on DC/AC When activating (input-output) When deactivating (input-output) At Power Loss	<90ms/<220ms <20 ms <20 ms <150 ms
Relay outputs NO NC Maximum switching capacity Resistive load AC Inductive load AC Resistive load DC Inductive load DC Maximum total switching capacity Resistive load Minimum load Contact material Fuses Output (External) Conditional short-circuit current (1 kA) Mechanical life	3 1 6A/250 VAC/1500 VA AC15 240VAC 2A 6A/24 VDC/150 W DC13 24VDC 1A 12A distributed on all contacts 10mA/10 V (if load on contact has not exceeded 100 mA) Ag+Au flash 5A gL/gG 6A gG >10 ⁷ operations

Transistor outputs External supply to Y13 Y14 Y24 Maximum load of Y14, Y24 Maximum voltage drop at maximum load	Short-circuit proof +5 to +30 VDC Indicates that the input conditions have been fulfilled Indicates that the output relays are activated 15 mA /output 2.4 V
LED indication On ● In1 ● In2 ● ☑ ● 1 ☑ ● 2	Supply voltage OK, the LED is on Flashing light in case of under-voltage or overload Indicates that the input conditions are fulfilled Indicates that the output relays are activated
Mounting Rail	35 mm DIN rail
Connection blocks (detachable) Maximum screw torque Maximum connection area Solid conductors Conductor with socket contact	1 Nm 1x4mm ² /2x1.5mm ² /12AWG 1x2.5mm ² /2x1mm ²
Protection class Enclosure Connection blocks	IP 40 IEC 60529 IP 20 IEC 60529
Operating temperature range	-10°C to + 55°C (with no icing or condensation)
Operating humidity range	35% to 85%
Impulse withstand voltage	2.5kV
Pollution degree	2
Performance (max.) The relays must be cycled at least once a year	Category 4/PL e (EN ISO 13849-1:2008) SIL 3 (EN 62061:2005) PFH _d 9.55E-09
Conformity	2006/42/EC, 2006/95/EC 2004/108/EC EN 954-1:1996 EN 62061:2005 EN ISO 13849-1:2008

Note:
Connector blocks are detachable without cables having to be disconnected.

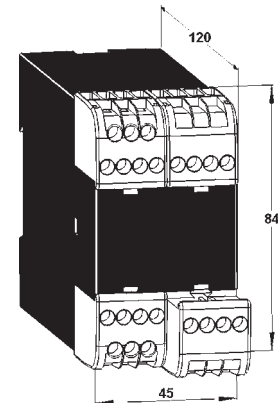

RT7 Safety Relay

Universal Relay with Delayed 'Stop' Outputs

The RT7 is a universal relay that can be used to supervise both safety devices and the internal safety of your machinery. In addition, you can select the safety level that is required for each installation. All this is possible because the RT7 has the most versatile input options arrangement available on the market. The RT7 can therefore replace many other relays.

The RT7 has four (4 NO) dual safety outputs of which two may be delayed for up to three seconds in order to achieve a safe and 'soft' stop. A 'soft' stop allows machinery to brake and stop gently before power is removed. A 'soft' stop has many benefits: The machinery life will be prolonged, processed products will not be damaged, and restarts from the stopped position are made possible and easier.

Another option with the RT7 is manual or automatic resetting. A manual supervised reset is used for gates and other safety devices that can be passed through, while an automatic reset is used for small safety hatches if deemed appropriate from a risk point of view.

In addition, the RT7 has information outputs that follow the inputs and outputs of the relay. These outputs indicate if for example a gate is opened or closed, if there is a delay or if the relay needs to be reset.

Choose the RT7 to simplify your safety circuits and reduce your costs.

Connection Examples

For examples of how our safety relays can solve various safety problems, see "Connection Examples" beginning on page 5:44.

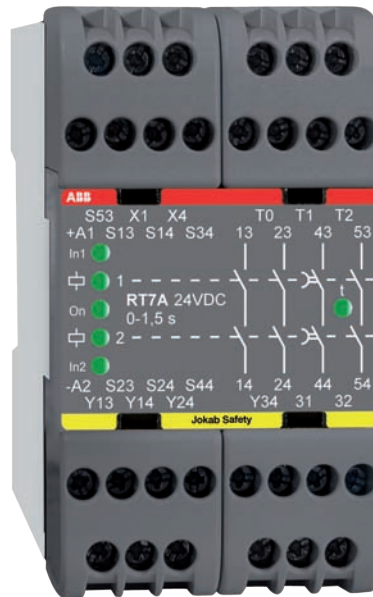

Applications

- Emergency Stops
- Light Curtains
- Three Position Devices
- Interlocked Gates/Hatches
- Magnetic Switches
- Light Beams
- Safety Mats
- Contact Strips
- Foot-Operated Switches

Features

- Five input options
- Single or dual channel input
- Manual supervised or automatic reset
- Test input for supervision of external contactors
- Width 45 mm
- LED indication of supply, inputs, outputs, short-circuit and low voltage level
- 4 NO/1 NC relay outputs, 2 NO outputs can be delayed for soft stops
- Delay times: RT7A 0; 0.5; 1.0; 1.5 s
RT7B 0; 1.0; 2.0; 3.0 s
- Three voltage free transistor information outputs
- 24 VDC
- 24, 48, 115 or 230 VAC
- Quick release connector blocks

Approvals



RT7 A/B Technical Information

Inputs

The RT7 can be configured to operate in either of the following input options:

1. Single channel, 1 NO contact from +24 VDC, safety category 1.
2. Dual channel, 2 NO contacts from +24 VDC, safety category 3.
3. Dual channel 1 NO, 1 NC contact from +24 VDC, safety category 4.
4. Dual channel, 1 NO contact from 0V and 1 NO contact from +24 VDC, safety category 4.
5. Safety mats/contact strips 1 'contact' from 0V and 1 'contact' from +24 VDC, safety category 1.

Note: Safety category only refers to the safety relay configuration, input devices, output devices and wiring must be considered for a safety category of the system.

When the input/inputs are activated and the test/supervised reset is complete, relays 1,2,3 and 4 are activated. Relays 1 and 2 are immediately de-energized when the inputs are deactivated in accordance with the input option selected. Relays 3 and 4 are either de-energized immediately or after the selected time delay. All the relays (1,2,3 and 4) must be de-energized before the RT7 can be reset.

Transistor Output Status Information

The RT7 has three voltage free transistor outputs that can be connected to a PLC, computer or other monitoring device. These outputs give the input and output status of the relay.

Reset and Testing

The RT7 has two reset options; manual and automatic. The manual supervised reset is used when the RT7 is monitoring safety devices that can be passed through, i.e. to ensure that the outputs of the safety relay do not close just because the gate is closed. The automatic reset should only be used if deemed an acceptable risk.

In addition, the RT7 can also test (supervise), if for example, contactors and valves etc. are de-energized/de-activated before a restart is allowed.

Indication of Low Voltage

The 'On' LED will flash if the relay supply voltage falls below an acceptable level. This indication will also be given if a monitored safety mat/contact strip is actuated. See connection option 5.

Safety Level

The RT7 has internal dual and supervised safety functions. Power failure, internal faulty component or external interference will not present a risk to options with the highest safety level. A manual reset requires that the reset input is closed and opened before the safety relay outputs are activated. A short-circuit or a faulty reset button is consequently supervised.

When the RT7 is configured for dual channel input, both the inputs are supervised for correct sequence operation before the unit can be reset.

The input options 3 and 4 have the highest safety levels as all short-circuits and power failures are supervised. This in combination with double internal current limitation makes the relay ideal for supervision of safety mats and contact strips.

Regulations and Standards

The RT7 is designed and approved in accordance with appropriate directives and standards. Examples of such are: 98/37/EC, EN ISO 12100-1/-2, EN 60204-1 and EN 954-1/EN ISO 13849-1.

Connection Examples

For examples of how our safety relays can solve various safety problems, see "Connection Examples" beginning on page 5:44.

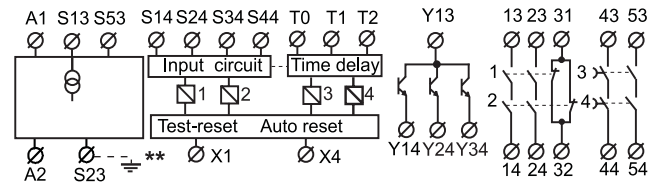

****Only for AC supply**

Connection of Supply

DC Supply

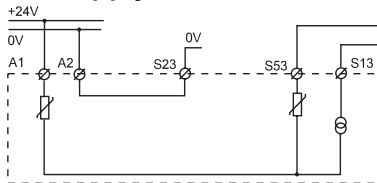

The RT7 DC option should be supplied with +24 V on A1 and 0 V on A2.

AC Supply

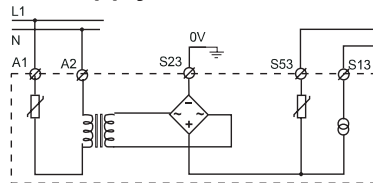

The RT7 AC option should be supplied with the appropriate supply voltage via connections A1 and A2. The S23/⊥ must be connected to protective earth.

DC Supply of AC Units

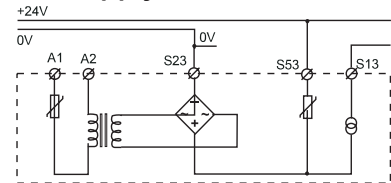

All AC-units can also be supplied by +24 VDC to S53 (0VDC to S23).

Note: With both DC and AC modules, if cable shielding is used this must be connected to an earth rail or an equivalent earth point.

RT7 A/B Connection of Safety Devices

1. Single Channel, 1 NO from +24V



The input (contact to S14) must be closed before the outputs can be activated. When the input contact is opened the relay safety output contacts open.

2. Dual Channel, 2 NO from +24V

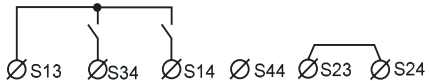

Both input contacts (S14 and S34) must be closed before the relay outputs can be activated. The safety relay contacts will open if one or both of the input contacts are opened. Both the input contacts must be opened and reclosed before the relay can be reset. A short-circuit between inputs S14 and S34 can only be supervised if the device connected to the inputs has short-circuit supervised outputs, e.g. Jokab Focus light curtains.

3. Dual Channel, 1 NO, 1 NC from +24V

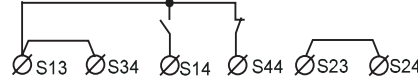

One input contact must be closed (S14) and one opened (S44) before the relay outputs can be activated. The safety relay contacts will open if one or both of the inputs change status or in case of a short-circuit between S14 and S44. Both inputs must return to their initial positions before the relay outputs can be reactivated.

4. Dual Channel, 1 NO from +24V, 1 NO to 0V



Relay functions as option 2, but a short-circuit, in this case between inputs S14 and S24, is supervised (safety outputs are opened).

5. Safety Mat or Contact Strip

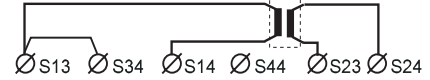

Both 'contact' inputs from an inactivated safety mat/contact strip must be made in order to allow the RT7 relay outputs to be activated. When the safety mat/contact strip is activated or a short-circuit is detected across S14-S23, the relay will de-energize (safety outputs open) and the 'ON' LED will flash. As output S13 has an internal current limit of 60 mA, the RT7 will not be overloaded when the mat/contact strip is activated or a short circuit is detected.

RT7 A/B Reset Connections

Manual Supervised Reset

The manual supervised reset contact connected to input X1 must be closed and opened in order to activate the relay outputs.

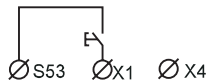

Automatic Reset

Automatic reset is selected when S53, X1 and X4 are linked. The relay outputs are then activated at the same time as the inputs.



**connected to S13 for safety mat/contact strip*

Testing External Contactor Status

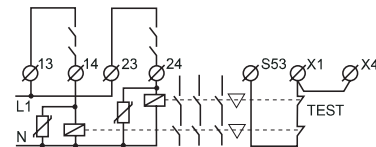

Contactors, relays and valves can be supervised by connecting 'test' contacts between S53 and X1. Both manual supervised and automatic reset can be used.

RT7 A/B Output Connections

Relay Outputs

The RT7 has four (4 NO) safety outputs, of which two can be delayed, and 1 NC information output.

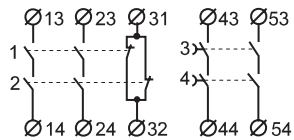

In order to protect the RT7 output contacts it is recommended that loads (inductive) are suppressed by fitting correctly chosen VDRs, diodes, etc. Diodes are the best arc suppressors, but will increase the switch off time of the load.

Transistor Outputs

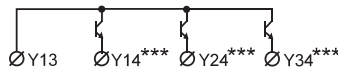

The RT7 has three (3) voltage free transistor information outputs.

The transistor outputs are supplied with voltage to Y13, either from S53 (+24V) or an external 5-30 VDC. Y14, Y24 and Y34 follow the relay inputs and outputs as follows:

- Y14 becomes conductive when the relay input conditions are fulfilled.
- Y24 becomes conductive when both the output relays are activated.
- Y34 becomes conductive when both the delay output relays are activated.

*****Note: These outputs are only for information purposes and must not be connected to the safety circuits of the machinery.**

Time Delay Outputs

RT7A	RT7B	T0	T1	T2	RT7A	RT7B	T0	T1	T2
0.0s	0.0s	Ø	Ø	Ø	1.0s	2.0s	Ø	Ø	Ø
0.5s	1.0s	Ø	Ø	Ø	1.5s	3.0s	Ø	Ø	Ø

Time delays are selected by linking the appropriate T0, T1 and T2 connections.

When a stop signal is detected a program stop command is first given to the PLC/servo which brakes the dangerous machine operations in a 'soft' and controlled way.

The delayed relay safety outputs will then turn off the power to the motors, i.e. when the machinery has already stopped. It takes usually around 0.5 to 3 seconds for a dangerous action to be stopped softly.

RT7 A/B Technical Data

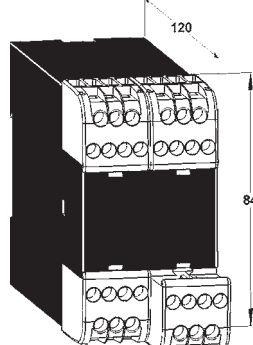
Manufacturer	ABB AB/Jokab Safety, Sweden		Conditional short-circuit current (1 kA), each output	6A gG
Ordering information	See page 5:62		Mechanical life	>10 ⁷ operations
Color	Grey		Transistor outputs External supply to Y13 Y14	+5 to +30 VDC Indicates that the input conditions are fulfilled
Weight	405 g (24 VDC) 550 g (24-230 VAC)		Y24	Indicates that the output relays 1/2 are activated
Supply Voltage (A1-A2)	24 VDC +15/-20%, 24/48/115/230 VAC, ±15%, 50-60 Hz		Y34	Indicates that the delay output relays 3/4 are activated
Power consumption DC supply, nominal voltage AC supply, nominal voltage	4.6 W 8.8 VA		Maximum load of Y14, Y24, Y34 Maximum voltage drop at maximum load	15 mA /output 2.4 V
Connection S13 Short-circuit protected voltage output, 70 mA ±10% current limitation (Is used for the inputs S14, S34 and S44)				
Connection S53 Short-circuit protected voltage output, internal automatic fuse, max 270 mA (Is used for the reset and autoreset inputs X1 and X4)				
Connection S23 0V connection for input S24				
Safety inputs S14 (+) input S24 (0V) input S34 (+) input S44 (+) input	20 mA 20 mA 20 mA 25 mA		LED indication On ● In1 ● In2 ● ☑ ● 1 ☑ ● 2 t ●	Supply voltage OK, the LED is on. Flashing light in case of under-voltage or overload Indicates that the input conditions are fulfilled Indicates that the output relays 1/2 are activated Indicates that the delay output relays 3/4 are activated
Reset input X1 Supply for reset input Reset current Minimum contact closure time for reset	+ 24VDC 600 mA current pulse at contact closure, then 30 mA 100 ms		Mounting Rail	35 mm DIN rail
Maximum external connection cable resistance at nominal voltage for S14, S24, S34 S44, X1	300 Ohm 150 Ohm		Connection blocks (detachable) Maximum screw torque Maximum connection area Solid conductors Conductor with socket contact	1 Nm 1x4mm ² /2x1.5mm ² /12AWG 1x2.5mm ² /2x1mm ²
Response time At Power on DC/AC When activating (input-output) When deactivating (input-output) At Power Loss	<90/<140 ms <20 ms <20 ms <80 ms		Protection class Enclosure Connection blocks	IP 40 IEC 60529 IP 20 IEC 60529
Delay time options RT7A RT7B	0; 0.5; 1.0; 1.5 secs 0; 1.0; 2.0; 3.0 secs		Operating temperature range 24VDC 24-230VAC	-10° C to + 55° C (with no icing or condensation) -10° C to + 45° C (with no icing or condensation)
Relay outputs NO direct (relays 1/2) NO direct or delayed (relays 3/4) NC (relays 1/2) Maximum switching capacity Relays 1/2 Resistive load AC Inductive load AC Resistive load DC Inductive load DC Relays 1/2 total	2 2 1 6A/250 VAC/1500 VA AC15 240VAC 2A 6A/24 VDC/150 W DC13 24VDC 1A Max 9A distributed on all contacts		Operating humidity range Impulse withstand voltage Pollution degree	35% to 85% 2.5kV 2
Relays 3/4 Resistive load AC Inductive load AC Resistive load DC Inductive load DC Relays 3/4 total	6A/230 VAC/1380 VA AC15 230VAC 4A 6A/24VDC/144W DC13 24VDC 2A Max 6A distributed on all contacts		Performance (max.) The relays must be cycled at least once a year	Category 4/PL e (EN ISO 13849-1:2008) SIL 3 (EN 62061:2005) PFH _d 9.55E-09
Contact material	AgSnO ₂ + Au flash		Conformity	2006/42/EC, 2006/95/EC 2004/108/EC EN 954-1:1996, EN 62061:2005 EN ISO 13849-1:2008
Fuses output 1/2 (external)	5A gL/gG		 <p>Note: Connector blocks are detachable without cables having to be disconnected.</p>	
Fuses output 3/4 (external)	3A gL/gG			

RT9 Safety Relay

Would you like a small safety relay for all your safety applications?

If so, then choose the compact RT9 universal relay to supervise both your safety devices and the internal safety of your machinery. In addition, you can select the safety level that is required for each installation. All this is possible due to the RT9 offering the most versatile input option arrangement available on the market. The RT9 can therefore replace many other relays.

Other RT9 options include selection of either manual supervised or automatic resetting. The manual supervised reset can be used for gates and other safety devices that can be passed through. Automatic reset can be used for small safety hatches, if deemed acceptable from risk assessment.

In addition, the RT9 has a dual function information output that will indicate, e.g. if a gate is open or if the relay needs resetting.

The RT9 uses the latest component technology and modern assembly techniques to ensure a highly cost effective solution.

Choose the RT9 to simplify your safety circuits and reduce your costs.

Connection Examples

For examples of how our safety relays can solve various safety problems, see “Connection Examples” beginning on page 5:44.

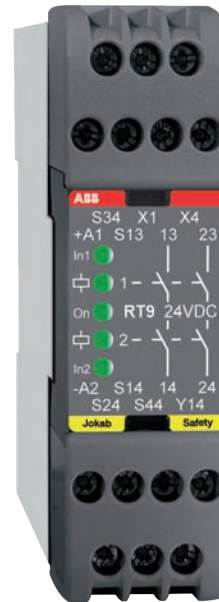

Applications

- Emergency Stops
- Light Curtains
- Three Position Devices
- Interlocked Gates/Hatches
- Magnetic Switches
- Light Beams
- Safety Mats
- Contact Strips
- Foot-Operated Switches

Features

- Five input options
- Single or dual channel input
- Manual supervised or automatic reset
- Test input for supervision of external contactors
- Width 22.5 mm
- LED indication of supply, inputs, outputs, short-circuit and low voltage level
- 2 NO relay outputs
- 1 changeover relay with a dual information output
- 24 VDC
- Detachable connection blocks

Approvals

TÜV Nord  

RT9 Technical Information

Inputs

The RT9 can be configured to operate in either of the following input options:

1. Single channel, 1 NO contact from +24 VDC, safety category 1.
2. Dual channel, 2 NO contacts from +24 VDC, safety category 3.
3. Dual channel, 1 NO, 1 NC contact from +24 VDC, safety category 4.
4. Dual channel, 1 NO contact from 0V and 1 NO contact from +24 VDC, safety category 4.
5. Safety mats/contact strips 1 'contact' from 0V and 1 'contact' from +24 VDC, safety category 1.

Note: Safety category only refers to the safety relay configuration, input devices, output devices and wiring must be considered for a safety category of the system.

When the input/inputs are activated and the test/supervised reset is complete, relays 1 and 2 are energized. These are de-energized when the input/ inputs are de-activated in accordance with the input option chosen or in case of a power failure. Relays 1 and 2 must both be de-energized before the RT9 can be reset.

Transistor Output Status Information

The RT9 has a changeover contact relay output that can be connected to a PLC, control lamp, computer or similar. The output gives information about the status of the relay.

Reset and Testing

The RT9 has two reset options; manual and automatic. The manual supervised reset is used when the RT9 is monitoring safety devices that can be passed through, i.e. to ensure that the outputs of the safety relay do not close just because a gate is closed. The automatic reset should only be used if deemed an acceptable risk.

Due to special internal circuits the RT9 can be automatically reset regardless of the operational voltage rise time, this being an important factor when large loads are started up on the same power supplies at the same time.

In addition, the RT9 can also test (supervise), if for example, contactors and valves, etc. are de-energized/ de-activated before a restart is made.

Connection of Supply DC Supply

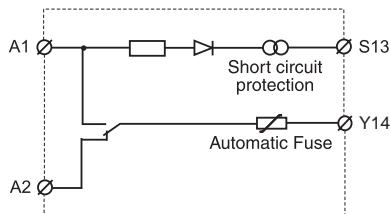

The RT9 should be supplied with +24 V on A1 and 0 V on A2.

Note: If cable shielding is used this must be connected to an earth rail or an equivalent earth point.

Indication of Low Voltage

The 'On' LED will flash if the relay supply voltage falls below an acceptable level. This indication will also be given if a monitored safety mat/contact strip is actuated.

Safety Level

The RT9 has internal dual and supervised safety functions. Power failure, internal faulty component or external interference will not present a risk to options with the highest safety level. A manual reset requires that the reset input is closed and opened before the safety relay outputs are activated. A short-circuit or a faulty reset button is consequently supervised.

When the RT9 is configured for dual channel input, both the inputs are supervised for correct operation before the unit can be reset.

The input options 3 and 4 have the highest safety levels as all short-circuits and power failures are supervised. This in combination with double internal current limitation makes the relay ideal for supervision of safety mats and contact strips.

Regulations and Standards

The RT9 is designed and approved in accordance with appropriate directives and standards. Examples of such are: 98/37/EC, EN ISO 12100-1/-2, EN 60204-1 and EN 954-1/EN ISO 13849-1.

Connection Examples

For examples of how our safety relays can solve various safety problems, see "Connection Examples" beginning on page 5:44.

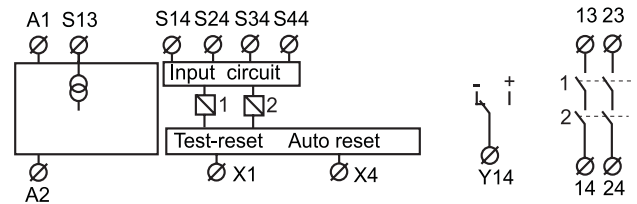

RT9 Connection of Safety Devices

1. Single Channel, 1 NO from +24V

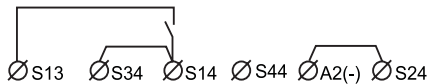

The input (contact to S14) must be closed before the outputs can be activated. When the input contact is opened the relay safety output contacts open.

2. Dual Channel, 2 NO from +24V

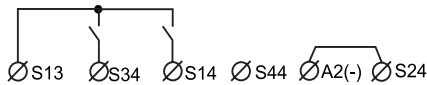

Both input contacts (S14 and S34) must be closed before the relay outputs can be activated. The safety relay contacts will open if one or both of the input contacts are opened. Both the input contacts must be opened and reclosed before the relay can be reset. A short-circuit between inputs S14 and S34 can only be supervised if the device connected to the inputs has short-circuit supervised outputs, e.g. Jokab Focus light curtains.

3. Dual Channel, 1 NO, 1 NC from +24V

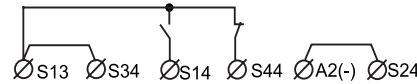

One input contact must be closed (S14) and one opened (S44) before the relay outputs can be activated. The safety relay contacts will open if one or both of the inputs change status or in case of a short-circuit between S14 and S44. Both inputs must return to their initial positions before the relay outputs can be reactivated.

4. Dual Channel, 1 NO from +24V, 1 NO to 0V

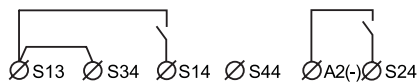

Relay functions as option 2, but a short-circuit, in this case between inputs S14 and S24, is supervised (safety outputs are opened).

5. Safety Mat or Contact Strip

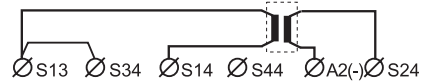

Both 'contact' inputs from an inactivated safety mat/contact strip must be made in order to allow the RT9 relay outputs to be activated. When the safety mat/contact strip is activated or a short-circuit is detected across S14-S23, the relay will de-energize (safety outputs open) and the 'ON' LED will flash. As output S13 has an internal current limit of 85 mA, the RT9 will not be overloaded when the mat/contact strip is activated or a short circuit is detected.

RT9 Reset Connections

Manual Supervised Reset

The manual supervised reset contact connected to input X1 must be closed and opened in order to activate the relay outputs.

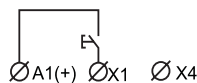

The manual supervised reset contact connected to input X1 must be closed and opened in order to activate the relay outputs.

Automatic Reset

Automatic reset is selected when A1(+), X1 and X4 are linked. The relay outputs are then activated at the same time as the inputs.

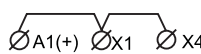

Testing External Contactor Status

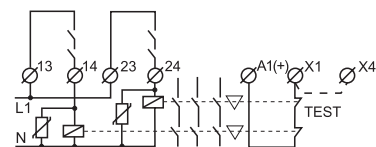

Contactors, relays and valves can be supervised by connecting 'test' contacts between A1(+) and X1. Both manual supervised and automatic reset can be used.

RT9 Output Connections

Relay Outputs

The RT9 has two (2 NO) safety outputs.

In order to protect the RT9 output contacts it is recommended that loads (inductive) are suppressed by fitting correctly chosen VDRs, diodes, etc. Diodes are the best arc suppressors, but will increase the switch off time of the load.

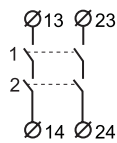

Transistor Outputs

The RT9 has a changeover contact information output.

The relay output Y14 is connected internally to 0V and 24V in the following way:

- Y14 is internally closed to 0V when the RT9 is not reset.
- Y14 is internally closed to +24V when the RT9 is reset.

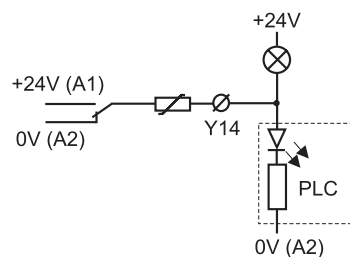

RT9 Technical Data

Manufacturer	ABB AB/Jokab Safety, Sweden
Ordering information	see page 5:63
Color	Grey
Weight	210 g
Supply Voltage (A1-A2)	24 VDC \pm 20%
Power consumption Nominal voltage	2 W
Connection S13	Short-circuit protected voltage output 70 mA \pm 10% current limitation (Is used for the inputs S14, S34 and S44)
Input currents (at nominal supply voltage)	
S14 (+) input	30 mA
S24 (0V) input	20 mA
S34 (+) input	20 mA
S44 (+) input	25 mA
Reset input X1 Supply for reset input Reset current	+ 24VDC 300 mA current pulse at contact closure, then 30 mA
Minimum contact closure time for reset	80 ms
Minimum contact closure time (at low limit voltage -20%)	100 ms
Maximum external connection cable resistance at a nominal voltage for S14, S24, S34 S44, X1	300 Ohm 150 Ohm
Response time	
At Power on	<100 ms
When activating (input-output)	<20 ms
When deactivating (input-output)	<20 ms
At Power Loss	<80 ms
Relay outputs	
NO	2
Maximum switching capacity	6A/250 VAC/1500 VA
Resistive load AC	AC15 240VAC 2A
Inductive load AC	6A/24 VDC/150 W
Resistive load DC	DC13 24VDC 1A
Inductive load DC	8A distributed on all contacts
Max. total switching capacity	
Minimum load	10 mA/10V (if load on contact has not exceeded 100 mA)
Contact material	Ag+Au flash
Fuses output (external)	5A gL/gG
Conditional short-circuit current (1 kA)	6A gG
Mechanical life	10 ⁷ operations
Relay information output Y14 (changeover contacts)	
-(0V)	Indicates that RT9 is not reset.
+(24V)	Indicates that RT9 is reset.
Maximum load of Y14	250 mA
Short-circuit protection for information output	Internal automatic fuse

LED indication	
On ●	Supply voltage OK, the LED is on Flashing light in case of under-voltage, overload or current limiting
In1 ● In2 ●	Indicates that the input conditions are fulfilled
☑ ● 1 ☑ ● 2	Indicates that the output relays have been activated
Mounting Rail	35 mm DIN rail
Connection blocks (detachable)	
Maximum screw torque	1 Nm
Maximum connection area	
Solid conductors	1x4mm ² /2x1.5mm ² /12AWG
Conductor with socket contact	1x2.5mm ² /2x1mm ²
Protection class	
Enclosure	IP 40 IEC 60529
Connection blocks	IP 20 IEC 60529
Operating temperature range	-10°C to + 55°C (with no icing or condensation)
Operating humidity range	35% to 85%
Impulse withstand voltage	2.5kV
Pollution degree	2
Performance (max.)	Category 4/PL e (EN ISO 13849-1:2008) SIL 3 (EN 62061:2005) PFH _d 9.55E-09
The relays must be cycled at least once a year	
Conformity	2006/42/EC, 2006/95/EC 2004/108/EC EN 954-1:1996, EN 62061:2005 EN ISO 13849-1:2008

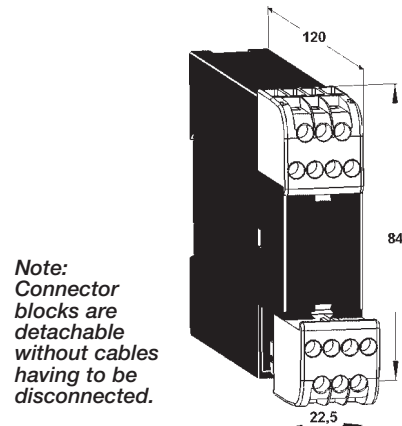

JSBRT11 Safety Relay

Flexible Safety Relay with Various Outputs

The JSBRT11 has been designed to provide the safety system circuit designer with the ability to select from both a range of input connection configurations and either automatic or supervised reset.

The unit can be hardware configured to operate in either of the following input configurations:

- Mode 1: Single Channel (1 NO contact from +24 VDC), safety category 1
- Mode 2: Dual Channel (2 NO contacts from +24 VDC), safety category 3
- Mode 3: Dual Channel (1NO, 1 NC contacts from +24 VDC), safety category 4
- Mode 5: Dual Channel (1 NO) contact from 0 V and 1 NO contact from +24 VDC), safety category 4

In addition, the unit can also be used to test that contactors and valves have fallen/returned to their 'reset' state before a new 'start' signal is given.

Safety Level

The JSBRT11 has dual and monitored internal safety functions. Power failure, internal component failures or external interference (with the exception of short circuiting of input contact when used in a single channel input mode) do not result in a dangerous function.

When wired for supervised reset, should a short circuit appear across the reset input the relay will not automatically reset when the input/inputs are made. Only when the supervised reset input is made and broken will the relay reset.

The JSBRT11 provides detection of contact failure in the inputs when wired in dual channel mode. Both inputs have to be opened and closed in order to enable the reactivation of the relay. The highest safety level of the JSBRT11 is in configuration mode 3 or 4 because all short circuits are supervised, i.e. a short circuit between the inputs leads to a safe state as the outputs drop out.

Connection Examples

For examples of how our safety relays can solve various safety problems, see "Connection Examples" beginning on page 5:44.

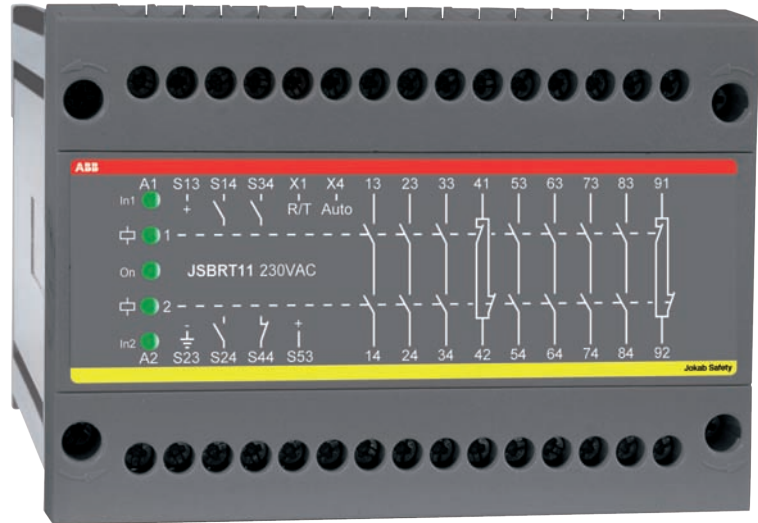

Applications

- Emergency Stops
- Light Curtains
- Three Position Devices
- Interlocked Gates/Hatches
- Magnetic Switches
- Light Beams
- Foot-Operated Switches

Features

- Selectable inputs and safety category
- Manual supervised or automatic reset
- Width 100 mm
- LED indication of supply, inputs and outputs
- 7 NO + 2 NC relay outputs
- Supply 24 VDC 24, 48, 115 or 230 VAC
- Quick release connector blocks

Regulations and Standards

The JSBRT11 is designed and approved in accordance with appropriate directives and standards. See Technical Data.

Approvals



JSBRT11 Technical Data

Manufacturer	ABB AB/Jokab Safety, Sweden	Response time at activation (input-output)	<30 ms
Ordering information	see page 5:63	Terminals (max. screw torque 1 Nm)	
Color	Grey	Single strand	1x4 mm ² /2x1.5 mm ²
Power supply A1 - A2	24 VDC ± 15% 24, 48, 115, 230 VAC ± 15%, 50-60 Hz	Conductor with socket contact	1x2.5 mm ² /2x1mm ²
Power consumption	3.2 W/7.9 VA	Mounting	35 mm DIN-rail
Relay outputs	7 NO and 2 NC	Protection class	
Maximum switching capacity		Enclosure	IP 40 IEC 60259
Resistive load AC	6A/250 VAC/1500 VA	Terminals	IP 20 IEC 60259
Inductive load AC	AC15 240VAC 2A	Impulse withstand voltage	2.5kV
Resistive load DC	6A/24 VDC/150 W	Pollution degree	2
Inductive load DC	DC13 24VDC 1A	Operating temperature range	-10°C to +55°C (with no icing or condensation)
Max. total switching capacity	21A distributed on all contacts	Operating humidity range	35% to 85%
Minimum load	10mA/10 V (if load on contact has not exceeded 100 mA)	Function indication	Electrical Supply, Input 1 and 2, Output relays 1 and 2
Contact material	AgSnO ₂ + Au flash	Weight	610 g (24 VDC) 790 g (24-230 VAC)
Fuses output (external)	6A gL/gG	Performance (max.)	Category 4/PL e (EN ISO 13849-1:2008)
Conditional short-circuit current (1 kA)	6A gG	Functional test	SIL 3 (EN 62061:2005)
Maximum input wire res. at nom. voltage	200 Ohm (S14,S24,S34,X1,X4); 100 Ohm (S44)	The relays must be cycled at least once a year	PFH _d 1.69E-08
Response time at deactivation (input-output)	<20 ms	Conformity	2006/42/EC, 2006/95/EC 2004/108/EC EN 954-1:1996, EN 62061:2005 EN ISO 13849-1:2008

JSBRT11 Technical Description

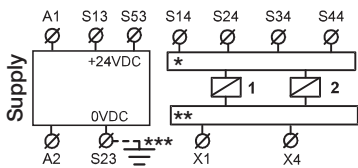

The supply voltage is connected across A1 and A2. The input connection configuration and type of reset required is set by connecting the unit as shown in the diagrams below. When the input/inputs and the test/supervised reset are made K1 and K2 energize. K1 and K2 will de-energize if the power is disconnected or a stop signal is given in accordance to the configuration mode wired. Both K1 and K2 have to be deactivated before the outputs of the JSBRT11 can be closed again.

Configuration Mode 1

When the single input opens both K1 and K2 relays are deactivated.

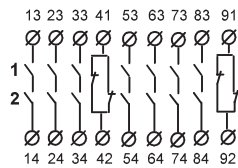

Configuration Mode 2

Both inputs have to be closed in order to enable the unit to be activated. A stop signal is given if both or one input is opened. Both inputs have to be opened and reclosed in order to enable the reactivation of the unit. If the possibility of short circuits between the inputs cannot be excluded, configuration mode 3 or 4 should be used in order to reach the high safety level.

Configuration Mode 3

One input has to be closed and the other input has to be opened in order to enable the unit to be activated. A stop signal is given if both or one input change state. Both inputs have to change state in order to give a dual stop function and to allow a new start after stop.

Configuration Mode 4

Operation as mode 2 but short circuits between the inputs leads to a safe state, i.e. the relays inside the JSBRT11 will drop out.

Supervised reset connection

The input to X1 (see diagram below) has to be closed and opened in order to activate the unit, after input/inputs are made according to the configuration mode selected. This mode is selected when X1 - X4 is open circuit.

Automatic reset connection

The input has to be closed in order to activate the unit after input/inputs are made according to the configuration mode selected. This mode is selected when a connection between X1 and X4 is made.

Test

Test contacts of contactors can be connected between S53 and X1 for supervision.

JSBRT11 Electrical Connections

Single Channel,* (Mode 1)

1 NO from +24V

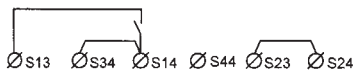

Dual Channel,* (Mode 2)

2 NO from +24V

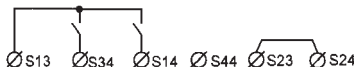

Dual Channel,* (Mode 3)

1 NO, 1 NC from +24V

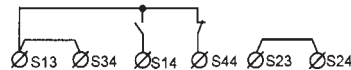

Dual Channel,* (Mode 4)

1 NO from +24V, 1 NO to 0V

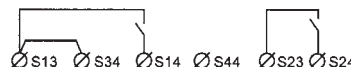

Supervised Manual Reset

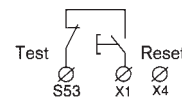

Automatic Reset

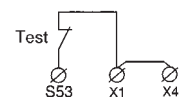

**Note: With the input conditions shown, the JSBRT11 is in its de-energized state, i.e. output contacts are open. It is recommended that all switched loads are adequately suppressed and/or fused in order to provide additional protection for the safety contacts.*

JSBR4 Safety Relay

Universal Relay for Two-Handed Devices

The JSBR4 has two inputs, which both have to be closed to keep the safety output contacts closed. A short circuit across the inputs will cause the output contacts to open. The inputs can however be subjected to a continuous short circuit without damaging the safety relay.

In order to make the safety outputs close the reset input must be closed and opened. In this way an unintentional reset is prevented in the case of a short circuit in the reset button cable or if the button gets jammed in the actuated position. The reset input can also be used for test/supervision to ensure that contactors or valves have returned to their initial off "stop" position before a new start can be allowed by the safety relay.

When the JSBR4 is used as a Two Hand relay both buttons have to be pressed within 0.5 seconds of each other in order to close the outputs.

When the JSBR4 is used for Safety Mats and Safety Strips the "stop" condition is given following detection of a short circuit between input channels A and B. Neither the safety mat, safety strip nor the relay will be damaged by a continuous short circuit. This also gives the advantage that if there is a failure between the inputs in the installation, the safety relay will not be damaged.

Safety Level

The JSBR4 has a twin supervised safety function. Neither component failure, short circuit or external disturbances (power loss, etc.) will prevent the safe function of the relay. This is valid both for the inputs A and B as well as for the reset input. The JSBR4 operates at the highest safety level for safety relays (PL e according to EN ISO 13849-1).

Connection Examples

For examples of how our safety relays can solve various safety problems, see "Connection Examples" beginning on page 5:44.

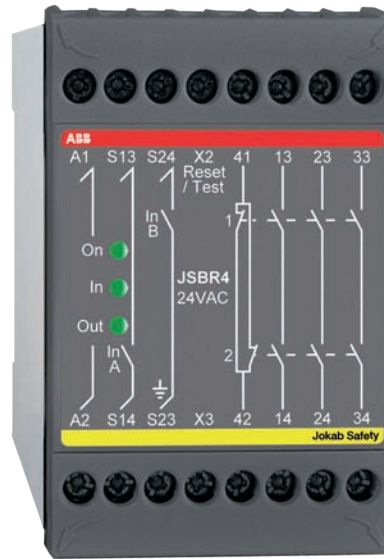

Applications

- Two-Handed Devices of Type IIIc
- Emergency Stops
- Three Position Devices
- Interlocked Gates/Hatches
- Safety Mats
- Contact Strips
- Foot-Operated Switches

Features

- Dual input channels synchronism 0.5s
- Supervised reset
- Test input
- Width 45 mm
- LED indication of supply, inputs and outputs
- 3 NO/1 NC relay outputs
- 24 VDC
- 24, 48, 115 or 230 VAC
- Quick release connector blocks

Regulations and Standards

The JSBR4 is designed and approved in accordance with appropriate directives and standards. See Technical Data.

The JSBR4 complies with the highest safety level for connection of a two-hand control device of type IIIc in accordance with EN574.

Approvals



JSBR4 Technical Data

Manufacturer	ABB AB/Jokab Safety, Sweden
Ordering information	see page 5:63
Color	Grey
Power supply	24 VDC ± 15% 24/48/115/230 VAC ± 15%, 50 - 60 Hz
Power consumption	1.3 W/3.3 VA
Relay outputs	3 NO + 1 NC
Maximum switching capacity	6A/250 VAC/1500 VA Resistive load AC Inductive load AC Resistive load DC Inductive load DC
Maximum res. load total switching capacity	12A distributed on all contacts
Minimum load	10mA/10 V (if load on contact has not exceeded 100 mA)
Contact material	Ag + Au flash
Fuses output (external)	5A gL/gG
Conditional short-circuit current (1 kA)	6A gG
Maximum input wire res. at nom. voltage	300 Ohm (S13 - S14 and S23 - S24)
Response time at deactivation	< 20 ms (145 ms at power loss)
Terminals (max. screw torque 1 Nm)	
Single strand	1 x 2.5 mm ² /2 x 1 mm ²
Conductor with socket contact	1 x 4 mm ² /2 x 1.5 mm ²
Mounting	35 mm DIN-rail

Protection class	IP 40/20 IEC 60529
Enclosure/Terminals	
Operating temperature range	-10°C to +55°C (with no icing or condensation)
Impulse withstand voltage	2.5kV
Pollution degree	2
Operating humidity range	35% to 85%
LED indication	Electrical Supply, Inputs, Outputs
Weight	350 g (24 VDC), 460 g (24-230 VAC)
Values	Safety Category 4 according to EN 954-1, PL e, SIL 3, PFH _d 1.35E-08
With proof test interval 1 year	
Conformity	2006/42/EC, 2006/95/EC 2004/108/EC EN 954-1:1996, EN 62061:2005 EN ISO 13849-1:2008

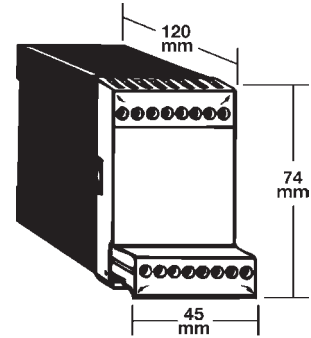

Note: Connector blocks are detachable without cables having to be disconnected.

JSBR4 Technical Description

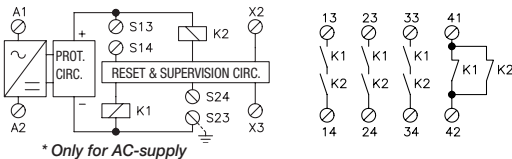

* Only for AC-supply

The electrical supply is connected across A1 and A2. After Voltage reduction and Rectification (AC-versions) or reverse polarization protection (DC-version) there is an overload protection-circuit.

When the inputs S13-S14 and S23-S24 have closed and the reset is made, the relays K1 and K2 are activated.

A dual stop signal is given when K1 and K2 drop, due to short circuiting between the inputs, opening of the inputs or power failure. If one input is opened the other input must also be opened for K1 and K2 to be activated again.

The monitoring circuit checks K1 and K2 and that the reset circuit to X2 is both closed and opened before K1 and K2 are energized. Both the stop and reset function therefore comply with the requirement that a component fault, short circuit or external interference do not result in a dangerous function.

The safety outputs consist of contacts from

K1 and K2 connected internally in series across terminals 13 - 14, 23 - 24 and 33 - 34. These contacts are used to cut the power to components which stop or prevent hazardous movements/functions. It is recommended that all switched loads are adequately suppressed and/or fused in order to provide additional protection for the safety contacts.

Note: Output 41-42 is intended for the indication purposes only, e.g. gate opened. No load between S14 and S24 allowed.

JSBR4 Electrical Connections

Emergency stop with manual resetting.

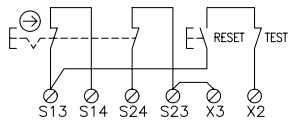

Interlocked gate with manual reset.

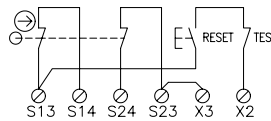

Contact mat or strip with manual reset.

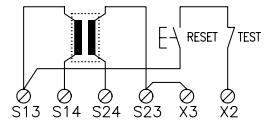

Two-hand device with buttons in separate or same enclosure. Buttons to be pressed in within 0.5 s of each other. Foot-pedal switches can be connected in the same configuration.

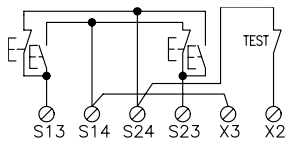

Enabling device JSHD4. Stop condition is given in both top and bottom PB positions.

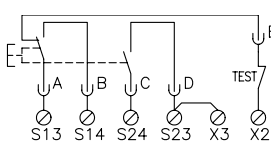

Control and supervision of external contactors, relay, valve or Jokab Safety's expansion relays.

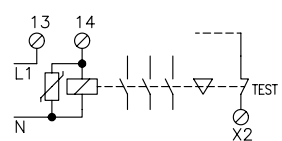

JSBT4 Safety Relay

Safety Relay with Synchronized Dual Input Channels (within 0.5s)

The JSBT4 has two inputs, both of which have to be closed in order to keep the safety output contacts closed. A short circuit between inputs A and B will cause the output contacts to open. The inputs can be continuously short circuit without damaging the safety relay.

For the outputs to close, the test input must be closed. The test input is intended to monitor that contactors or valves have dropped/returned before a new start is permitted.

This test input must not be confused with the reset function required for gates that a person can walk through and where there is a high safety requirement (see JSBR4).

If the JSBT4 is used for safety Mats and Safety Strips, the "stop" condition is given following detection of a short circuit. Neither the Safety Mat, Safety Strip nor the relay will be damaged by a continuous short circuit. This also provides the advantage that if there is a failure between inputs A and B in the installation, the safety relay will not be damaged.

Safety Level

The JSBT4 has a twin supervised safety function. Neither component failure, short circuit or external disturbances (power loss, etc.) will prevent the safe function of the relay. (Category 3 or 4 depending on use.)

The true two channel safety function has the advantage that the cabling installation demands for safety can be reduced due to the fact that a short circuit between the inputs will directly open the relays safety outputs.

Connection Examples

For examples of how our safety relays can solve various safety problems, see "Connection Examples" beginning on page 5:44.

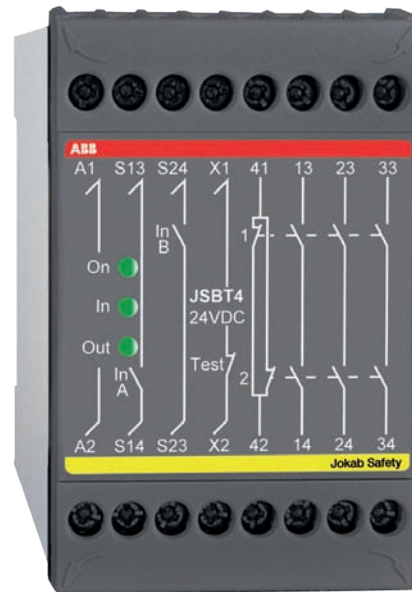

Applications

- Emergency Stops
- Three Position Devices
- Interlocked Gates/Hatches
- Safety Mats
- Contact Strips
- Foot-Operated Switches

Features

- Dual channel input synchronism 0.5 s
- Test input
- Width 45 mm
- LED indication of power on, inputs and outputs
- 3 NO/1 NC relay outputs
- 24 VDC
- 24, 48, 115 or 230 VAC
- Quick release connector blocks

Regulations and Standards

The JSBT4 is designed and approved in accordance with appropriate directives and standards. See Technical Data.

Approvals

TÜV Nord  

JSBT4 Technical Data

Manufacturer	ABB AB/Jokab Safety, Sweden
Ordering information	see page 5:64
Color	Grey
Power supply	24 VDC ± 15% 24/48/115/230VAC ± 15%, 50 - 60 Hz
Power consumption	1.6 W/3.8 VA
Relay outputs	3 NO + 1 NC
Maximum switching capacity	Resistive load AC 6A/250 VAC/1500 VA Inductive load AC AC15 240VAC 2A Resistive load DC 6A/24 VDC/150 W Inductive load DC DC13 24VDC 1A
Maximum res. load total switching capacity	12A distributed on all contacts
Minimum load	10mA/10 V (if load on contact has not exceeded 100 mA)
Contact material	Ag + Au flash
Fuses output (external)	5A gL/gG
Conditional short-circuit current (1 kA)	6A gG
Maximum input wire res. at nom. voltage	300 Ohm (S13 - S14 and S23 - S24)
Response time at deactivation	< 20 ms, 145 ms with switched supply/power loss

Terminals (max. screw torque 1 Nm)	
Single strand	1 x 4 mm ² /2 x 1.5 mm ²
Conductor with socket contact	1 x 2.5 mm ² /2 x 1 mm ²
Mounting	35 mm DIN-rail
Protection class	
Enclosure/Terminals	IP 40/20 IEC 60529
Operating temperature range	-10°C to +55°C (with no icing or condensation)
Impulse withstand voltage	2.5kV
Pollution degree	2
Operating humidity range	35% to 85%
LED indication	Electrical Supply, Inputs, Outputs
Weight	350 g (24VDC), 460 g (24-230VAC)
Values	
With proof test interval 1 year	Safety Category 4 according to EN 954-1, PL e, SIL 3, PFH _d 1.51E-08
Conformity	2006/42/EC 2006/95/EC 2004/108/EC EN 954-1:1996, EN 62061:2005 EN ISO 13849-1:2008

JSBT4 Technical Description

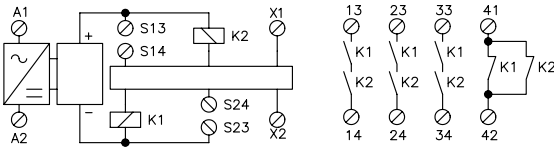

The electrical supply is connected across A1 and A2. After Voltage reduction and Rectification (AC-versions) or reverse polarization protection (DC-version) there is an overload protection-circuit.

When the inputs S13-S14 and S23- S24 are closed within 0.5 seconds the relays K1 and K2 are energized . A dual stop signal is given, K1 and K2 de-energize, when there is a short circuit between an

opening of the inputs and at power loss. If one input is opened the other one also has to be opened in order to activate K1 and K2 again. The test circuit, X1- X2, has to be closed in order to activate the outputs, thereafter the test circuit can be opened or closed continuously. If the test circuit is closed after the inputs there is no requirement to close them within 0.5 seconds.

The internal supervision circuit monitors the two Inputs and relays K1, K2. The stop function then fulfills the requirement that one failure (short circuit, component, external disturbance) shall not prevent the safe function of the JSBT4.

The safety outputs consist of contacts from K1 and K2 connected internally in series across terminals 13-14, 23-24 and 33-34. These contacts are used to cut the power to components which stop or prevent hazardous movements/functions. It is recommended that all switched loads are adequately suppressed and/or fused in order to provide additional protection for the safety contacts.

The NC output 41-42 should only be used for monitoring purpose e.g. Indication lamp or PLC input, etc. The output contacts are closed until the module is reset.

Note: Output 41-42 is intended for the indication purposes only, e.g. gate opened. No load between S14 and S24 allowed.

JSBT4 Electrical Connections

Emergency stop with automatic resetting.

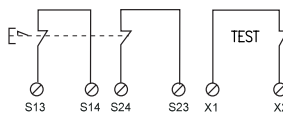

Interlocked hatch with automatic resetting.

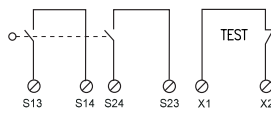

Contact mat or strip with automatic reset.

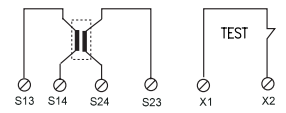

Monitoring to ensure that the Start button cannot stick in pressed position. Short circuiting over the closing contact is not monitored. The RT-series and JSBR4 have built-in short circuiting monitored resetting.

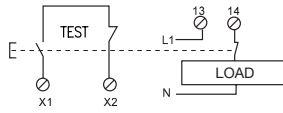

Enabling device JSHD4. Stop condition is given in both top and bottom PB positions.

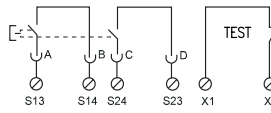

Control and supervision of external contactors, relay, valve or Jokab Safety's expansion relays.

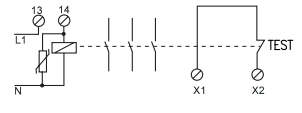

BT50(T) Safety Relay/ Expansion Relay

Single Channel Safety Relay

The BT50 is designed to connect safety devices, such as emergency stops, directly in the voltage supply circuit to the relay. Despite a maximum built-in width of only 22.5 mm, the relay is very powerful.

With 3 NO safety outputs, 1 NC output (for monitoring purposes), a test input and complete internal supervision, the BT50 is quite unique. In addition, delayed outputs (BT50T) can be ordered.

In order for the safety outputs to close, the supply voltage, by means of an emergency stop button, must be connected to A1 and A2 and the test input closed. After actuation of the relay the test input can be opened again.

The test input is intended to supervise that contactors or valves have dropped/returned before a new start can be permitted. The test input can also be used for starting and the start button can be supervised (see Connection Example on next page).

More Outputs

By connecting BT50 to a safety relay/PLC it is easy to increase the number of safe outputs. This means that an unlimited number of dangerous machine operations and functions can be stopped from one safety relay/PLC.

Safety Level

The BT50 has a twin and supervised internal safety function. Power failure, internal component faults or external interference cannot result in dangerous functions.

Input via A1 only is not protected from short circuiting and therefore installation is critical for the safety level to be achieved. To achieve a higher safety level, a screened cable can be used and/or connection made to both A1 and A2 (see Technical Description on next page).

Connection Examples

For examples of how our safety relays can solve various safety problems, see “Connection Examples” beginning on page 5:44.



Applications

- Emergency Stops
- Interlocked Hatches
- Expansion of Safety Outputs

Features

- Width 22.5 mm
- LED indication
- 3 NO/1 NC relay outputs
- Test/reset input
- 24 VDC
- Single or dual channel
- BT50 - Additional power terminals
- Quick release connector blocks
- BT50T - 1 changeover relay with a double information output (Y14)
- BT50T - Delay times selectable from 0 to 1.5 s

Regulations and Standards

The BT50 is designed and approved in accordance with appropriate directives and standards. See Technical Data.

Approvals

TÜV Nord  

BT50(T) Technical Data

Manufacturer	ABB AB/Jokab Safety, Sweden
Ordering information	see page 5:64
Color	Grey
Operational voltage	24 VDC + 15%/-25%
Power consumption	1.4 W/1.8 W
Relay outputs	3 NO + 1 NC
Maximum switching capacity	
Resistive load AC	6A/250 VAC/1500 VA
Inductive load AC	AC15 240VAC 2A
Resistive load DC	6A/24 VDC/150 W
Inductive load DC	DC13 24VDC 1A
Maximum res. load total switching capacity	12A distributed on all contacts
Minimum load	10mA/10 V(if load on contact has not exceeded 100 mA)
Contact material	Ag + Au flash
Fuses output (external)	5A gL/gG
Conditional short-circuit current (1 kA)	6A gG
Maximum input wire res. at nom. voltage	200 Ohms
Response time at deactivation (input - output)	Version B <20 ms or delayed max 1500 ms (old version of BT50 <60 ms)

Terminals (max. screw torque 1 Nm)	
Single strand	2x1.5 mm ²
Conductor with socket contact	2x1mm ²
Mounting	35 mm DIN-rail
Protection class	
Enclosure/Terminals	IP 40/20 IEC 60529
Impulse withstand voltage	2.5kV
Pollution degree	2
Operating temperature range	-10°C to +55°C (with no icing or condensation)
Operating humidity range	35% to 85%
LED indication	Electrical Supply, Relay and X4
Weight	200 g
Performance (max.)	
Functional test	Category 4/PL e (EN ISO 13849-1:2008)
The relays must be cycled at least once a year	SIL 3 (EN 62061:2005) PFH _d 1.22E-08
Conformity	2006/42/EC, 2006/95/EC 2004/108/EC EN 954-1:1996, EN 62061:2005 EN ISO 13849-1:2008

BT50(T) Technical Description

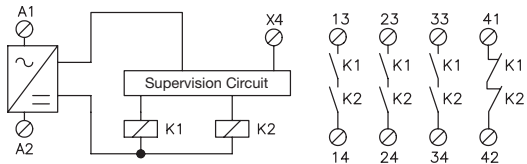

When supply voltage is connected to A1 and A2, relays K1 and K2 are activated. K1 and K2 drop if the supply voltage is disconnected. Both relays K1 and K2 must drop for them to be activated again. The test circuit, A1 - X4 can either be open or constantly closed.

The supervising circuit ensures that both

K1 and K2 have dropped before they can be reactivated. The stop function complies with the requirement that a component fault or external interference cannot lead to a dangerous function.

The safety outputs consist of contacts from K1 and K2 connected internally in series across terminals 13-14, 23-24, and 33-34. These contacts are used to cut the power to components which stop or prevent hazardous movements/functions. It is recommended that all switched loads are adequately suppressed and/or fused in order to provide

additional protection for the safety contacts.

The NC output 41-42 should only be used for monitoring purposes e.g. indication lamp for emergency stop pressed.

JSB50T Information Output

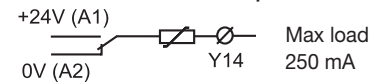

JSBT50T Delay Times

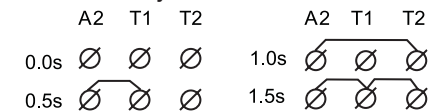

BT50(T) Electrical Connections

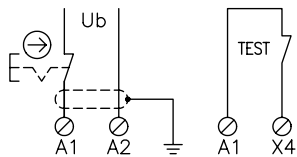

Emergency stop with reset when emergency button returns.

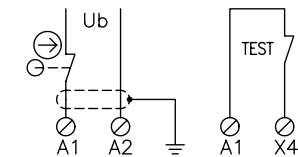

Hatch with automatic reset.

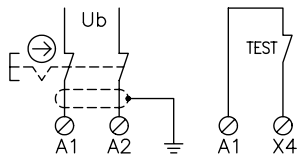

Emergency stop with dual connection direct to the supply voltage.

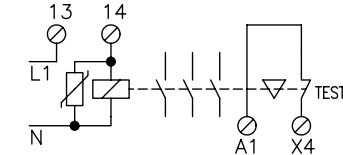

Controlled monitoring of external contactor, relay, valve or Jokab Safety's expansion relays.

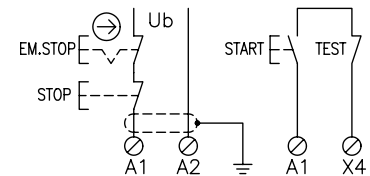

JSBT50 as emergency stop and control relay with Start and Stop function.

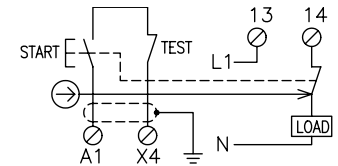

Monitoring to ensure that the On button is not stuck in pressed position. A short circuit over the closing contact is not monitored.

***Note: BT50 has additional power terminals A1 and A2.**

BT51(T) Safety Relay/ Expansion Relay

Single Channel Safety Relay

The BT51 is designed to connect safety devices, such as emergency stops, directly in the voltage supply circuit to the relay. Despite a maximum built-in width of only 22.5 mm, the relay is very powerful.

With 4 NO safety outputs, test input and complete internal supervising, the BT51 is quite unique. In addition you can order delayed outputs (BT51T).

In order for the safety outputs to close, the supply voltage, by means of an emergency stop button, must be connected to A1 and A2 and the test input closed. After actuation of the relay the test input can be opened again.

The test input is intended to supervise that contactors or valves have dropped/returned before a new start can be permitted. The test input can also be used for starting and the start button can be supervised (see Connection Example on next page).

More Outputs

By connecting BT51 to a safety relay/PLC it is easy to increase the number of safe outputs. This means that an unlimited number of dangerous machine operations and functions can be stopped from one safety relay/PLC.

Safety Level

The BT51 has a twin and supervised internal safety function. Power failure, internal component faults or external interference cannot result in dangerous functions.

Input via A1 only is not protected from short circuiting and therefore installation is critical for the safety level to be achieved. To achieve a higher safety level, a screened cable can be used and/or connection made to both A1 and A2 (see Technical Description on next page).

Connection Examples

For examples of how our safety relays can solve various safety problems, see "Connection Examples" beginning on page 5:44.



Applications

- Emergency Stops
- Interlocked Hatches
- Expansion of Safety Outputs

Features

- Width 22.5 mm
- LED indication
- 4 NO relay outputs
- Test/reset input
- 24 VDC
- Single or dual channel
- BT51 - Additional power terminals
- Quick release connector blocks
- BT51T - 1 changeover relay with a double information output (Y14)
- BT51T - Delay times selectable from 0 to 1.5 s

Regulations and Standards

The BT51 is designed and approved in accordance with appropriate directives and standards. See Technical Data.

Approvals

TÜV Nord  

BT51(T) Technical Data

Manufacturer	ABB AB/Jokab Safety, Sweden
Ordering information	see page 5:64
Color	Grey
Operational voltage	24 VDC + 15%/-25%
Power consumption	1.4 W/1.8 W
Relay outputs	4 NO
Maximum switching capacity	
Resistive load AC	6A/250 VAC/1500 VA
Inductive load AC	AC15 240VAC 2A
Resistive load DC	6A/24 VDC/150 W
Inductive load DC	DC13 24VDC 1A
Maximum res. load total switching capacity	12 A distributed on all contacts
Minimum load	10mA/10 V (if load on contact has not exceeded 100 mA)
Contact material	Ag + Au flash
Fuses output (external)	5A gL/gG
Conditional short-circuit current (1 kA)	6A gG
Maximum input wire res. at nom. voltage	200 Ohms
Response time at deactivation	<20 ms or delayed max 1500 ms (BT51T)

Terminals (max. screw torque 1 Nm)	
Single strand	2x1.5 mm ²
Conductor with socket contact	2x1mm ²
Mounting	35 mm DIN-rail
Protection class	
Enclosure/Terminals	IP 40/20 IEC 60529
Impulse withstand voltage	2.5kV
Pollution degree	2
Operating temperature range	-10°C to +55°C (with no icing or condensation)
Operating humidity range	35% to 85%
LED indication	Electrical Supply, Relay and X4
Weight	200 g
Performance (max.)	
Functional test	Category 4/PL e (EN ISO 13849-1:2008)
The relays must be cycled at least once a year	SIL 3 (EN 62061:2005) PFH _d 1.63E-08
Conformity	2006/42/EC, 2006/95/EC 2004/108/EC EN 954-1:1996, EN 62061:2005 EN ISO 13849-1:2008

BT51(T) Technical Description

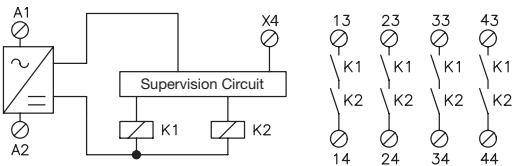

When supply voltage is connected to A1 and A2, relays K1 and K2 are activated. K1 and K2 drop if the supply voltage is disconnected. Both relays K1 and K2 must drop for them to be activated again. The test circuit, A1 - X4 can either be open or constantly closed.

The supervising circuit ensures that both K1 and K2 have dropped before they can be reactivated. The stop function complies with the requirement that a component fault or external interference cannot lead to a dangerous function.

The safety outputs consist of contacts from K1 and K2 connected internally in series across terminals 13-14, 23-24, 33-34 and 43-44. These contacts are used to cut the power to components which stop or prevent hazardous movements/functions. It is recommended that all

switched loads are adequately suppressed and/or fused in order to provide additional protection for the safety contacts.

JSB51T Information Output

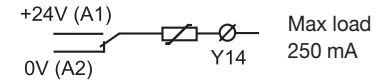

JSBT51T Delay Times

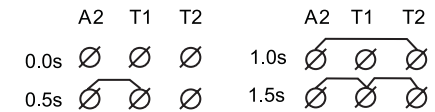

BT51(T) Electrical Connections

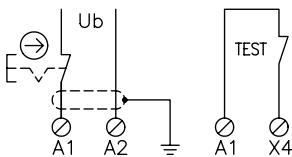

Emergency stop with reset when emergency button returns.

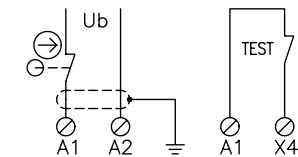

Hatch with automatic reset.

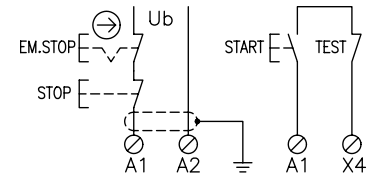

JSBT51 as emergency stop and control relay with Start and Stop function.

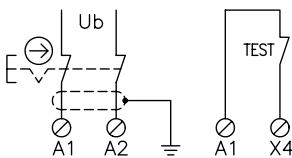

Emergency stop with dual connection direct to the supply voltage.

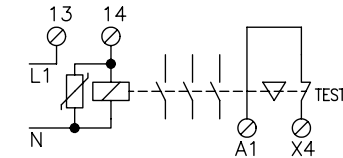

Controlled monitoring of external contactor, relay, valve or Jokab Safety's expansion relays.

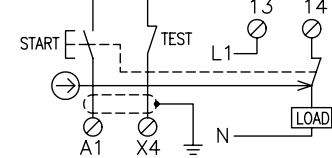

Monitoring to ensure that the On button is not stuck in pressed position. A short circuit over the closing contact is not monitored.

**Note: BT51 has additional power terminals A1 and A2.*

JSBT5(T) Safety Relay

Single Channel Safety Relay

The JSBT5 is designed to connect safety devices, such as emergency stops, directly in the voltage supply circuit to the relay. Despite a maximum built-in width of 22.5 mm the relay is very powerful.

With 3 NO safety outputs, 1 NC, test input and complete internal supervising, the JSBT5 is quite unique. In addition you can order delayed outputs (JSBT5T).

In order for the safety outputs to close, the supply voltage, e.g. by means of an emergency stop button, must be connected to A1 and A2 and the test input closed. After actuation of the relay the test input can be opened again.

The test input is intended to supervise that contactors or valves have dropped/returned before a new start can be permitted. The test input can also be used for starting and the start button can be supervised (see connection example on next page).

Safety Level

The JSBT5 has a twin and supervised internal safety function. Power failure, internal component faults or external interference cannot result in dangerous functions.

Input via A1 only is not protected from short circuiting, and therefore installation is critical for the safety level to be achieved. To achieve a higher safety level a screened cable can be used and/or connection made to both A1 and A2.

Connection Examples

For examples of how our safety relays can solve various safety problems, see “Connection Examples” beginning on page 5:44.



Applications

- Emergency Stops
- Interlocked Hatches

Features

- Width 22.5 mm
- LED indication
- 3 NO/1NC relay outputs
- Test/start input
- Supply 12VDC, 24 VDC/AC
- Single or dual channel
- (T) = delayed outputs 0.5 seconds

Regulations and Standards

The JSBT5(T) is designed and approved in accordance with appropriate directives and standards. See Technical Data.

Approvals



JSBT5(T) Technical Data

Manufacturer	ABB AB/Jokab Safety, Sweden
Ordering information	see page 5:64
Color	Grey
Operational voltage JSBT5 JSBT5T	24 VDC/AC + 15%–25%, 50–60 Hz 12 VDC, 24 VDC/AC + 15%–25%, 50 - 60 Hz
Power consumption	1 W/1.9 VA
Relay outputs	3 NO + 1 NC
Max. switching capacity Resistive load AC Inductive load AC Resistive load DC Inductive load DC	6A/250 VAC/1500 VA AC15 240VAC 2A 6A/24 VDC/150 W DC13 24VDC 1A
Maximum res. load total switching capacity	9A distributed on all contacts
Minimum load	10mA/10 V (if load on contact has not exceeded 100 mA)
Contact material	AgCuNi
Fuses output (external)	5A gL/gG
Conditional short-circuit current (1 kA)	6A gG
Maximum input wire res. at nom. voltage	200 Ohm

Response time at deactivation	<60 ms or delayed max 500 ms (JSBT5T)
Terminals (max. screw torque 1 Nm) Single strand Conductor with socket contact:	2x1.5 mm ² 2x1mm ²
Mounting	35 mm DIN-rail
Protection class Enclosure/Terminals	IP 40/20 IEC 60529
Impulse withstand voltage	2.5kV
Pollution degree	2
Operating temperature range	-10°C to +55°C (with no icing or condensation)
Operating humidity range	35% to 85%
Function indication	Electrical Supply
Weight	200 g
Performance (max.) Functional test The relays must be cycled at least once a year	Category 4/PL e (EN ISO 13849-1:2008) SIL 3 (EN 62061:2005) PFH _d 1.22E-08
Conformity	2006/42/EC, 2006/95/EC 2004/108/EC EN 954-1:1996, EN 62061:2005 EN ISO 13849-1:2008

JSBT5(T) Technical Description

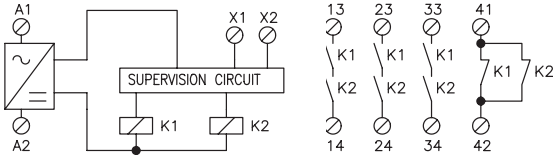

When supply voltage is connected to A1 and A2, relays K1 and K2 are activated. K1 and K2 drop if the supply voltage is disconnected. Both relays K1 and K2 must drop for them to be activated again. Another requirement is that the test

circuit, X1 - X2, must be closed for the outputs to be activated. Thereafter X1 - X2 can either be open or constantly closed. The supervising circuit ensures that both K1 and K2 have dropped before they can be reactivated. The stop function complies with the requirement that a component fault or external interference cannot lead to a dangerous function. The safety outputs consist of contacts from K1 and K2 connected internally in

series across terminals 13 - 14, 23 - 24, and 33 - 34. These contacts are used to cut the power to components which stop or prevent hazardous movements/functions. It is recommended that all switched loads are adequately suppressed and/or fused in order to provide additional protection for the safety contacts.

The NC output 41 - 42 should only be used for monitoring purposes e.g. indication lamp for emergency stop pressed.

JSBT5(T) Electrical Connections

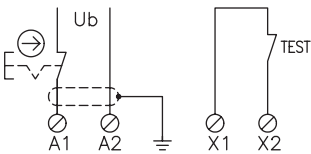

Emergency stop with reset when emergency button returns.

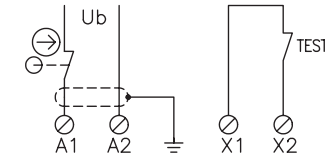

Hatch with automatic reset.

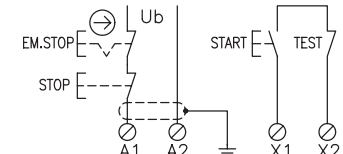

JSBT5(T) as emergency stop and control relay with Start and Stop function.

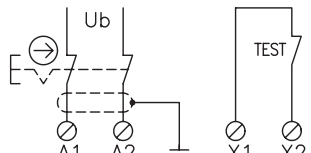

Emergency stop with dual connection direct to the supply voltage.

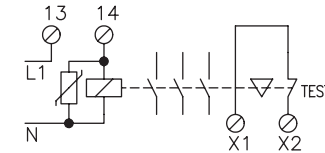

Controlled monitoring of external contactor, relay, valve or Jokab Safety's expansion relays.

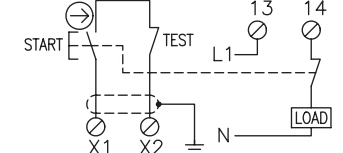

Monitoring to ensure that the On button is not stuck in pressed position. A short circuit over the closing contact is not monitored. The JSBR4 has built in short circuit monitored resetting.

*Note: BT51 has additional power terminals A1 and A2.

JSHT1 A/B Safety Timer closes 2 independent relay outputs during a guaranteed maximum time when the inputs are opened

Time Reset

Time reset can prevent unintentional reset of safety system when someone is still in the dangerous area of the machine. During a guaranteed maximum time, one or several PB's for reset must be activated. The reset buttons should be sited in such a way that operatives have a clear overview of the whole area which is guarded. Time reset is made by the combination of a safety relay and the timer relay JSHT1A/B.

Time Bypassing

The JSHT1 can also be used for time bypass of light beams, for example, a forklift into a dangerous area.

Operation

When the inputs open the output contacts close. The output contacts open when the inputs close or when the time period has expired. The time period is hardwire selectable on terminals T1, T2 and T3. The time given is the maximum time. One or two channel operation is also hardwire selectable.

Connection Examples

For examples of how our safety relays can solve various safety problems, see "Connection Examples" beginning on page 5:44.

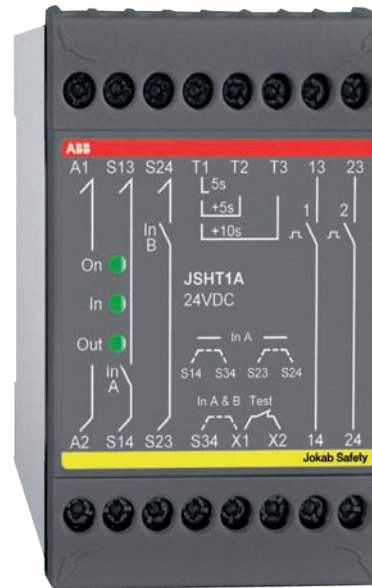

Applications

- Time Reset
- Time Bypassing

Features

- Hardwire time selection 5 - 40 s
- Selectable single or dual channel input
- Test input
- Width 45 mm
- LED indication for supply, inputs and outputs
- 1+1 NO relay outputs
- 24 VDC
- 24/48/115/230 VAC
- Quick release connector blocks

Regulations and Standards

The JSHT1 A/B is designed and approved in accordance with appropriate directives and standards. See Technical Data.

Approvals

TÜV Nord  

JSHT1 A/B Technical Data

Manufacturer	ABB AB/Jokab Safety, Sweden
Ordering information	see page 5:64
Color	Grey
Power supply	24 VDC ± 15 %, 24/48/115/230 VAC ± 15 %, 50 - 60 Hz (AC versions JSHT1A only)
Power consumption	1.8 W/3.7 VA
Max input wire res. at nom voltage/channel	100/200 Ohm (1 Channel/ 2 Channel)
Response time at activation	<30ms
Response time at deactivation	< 15 ms
Selectable time (± 15 % at nom. V.)	JSHT1A: 5-10-15-20 sec JSHT1B: 5-15-30-40 sec
Relay outputs	2 x 1 NO
Maximum switching capacity	4A/250 VAC/1000 VA Resistive load AC Inductive load AC Resistive load DC Inductive load DC
Max. total switching capacity	8A distributed on all contacts
Minimum load	10mA/10 V (if load on contact has not exceeded 100 mA)
Contact material	AgCuNi
Fuses output (external)	3A gL/gG or 4A fast
Conditional short-circuit current (1 kA)	6A gG

Max input wire res. at nom. voltage	100 Ohm
Terminals (max. screw torque 1 Nm)	
Single strand	1 x 4 mm ² , 2 x 1.5 mm ²
Conductor with socket contact	1 x 2.5 mm ² , 2 x 1 mm ²
Mounting	35 mm DIN-rail
Protection class	
Enclosure/Terminals	IP20/IP40 IEC 60529
Impulse withstand voltage	2.5kV
Pollution degree	2
Operating temperature range	-10°C to +55°C (with no icing or condensation)
Operating humidity range	35% to 85%
LED indication	Electrical Supply, Inputs, Outputs
Weight	24 VDC: 330 g 24/48/115/230 VAC: 430 g
Performance (max.)	
Functional test	Category 4 / PL e (EN ISO 13849-1:2008)
The relays must be cycled at least once a year.	SIL 3 (EN 62061:2005) PFH _d 4.42E-09
Conformity	2006/42/EC, 2006/95/EC 2004/108/EC EN 954-1:1996, EN 62061:2005 EN ISO 13849-1:2008

JSHT1 A/B Technical Description

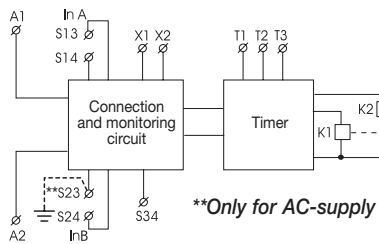

and the outputs close. K1 and K2 are activated for the hardwired selected time (set by connections on the terminals T1, T2 and T3). If there is a short circuit between the inputs or the inputs are closed again before the set time period has expired the outputs will open. In order to close the outputs again, both the inputs have to be closed and both internal relays K1 and K2 deactivated (controlled by the supervising circuit) and the inputs again opened. By external hardwire connections the JSHT1 can be made single or dual channel input. See figure below.

The electrical supply is connected across A1 and A2. The internal supervising circuit is activated directly when the supply is on. The inputs A and B must both be closed and then opened. Thereafter K1 and K2 are activated

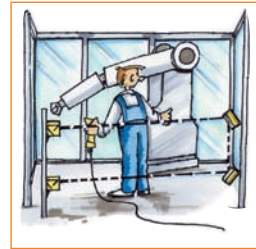

Light beam being bypassed for a maximum pre-set time e.g. 5 sec. by the JSHT1 during entrance and exit with the JSHT4 Three Position Enabling device.



Time reset procedure. First push PB1, then exit dangerous area and close the door, then push PB2 (PB1 and PB2 must be pressed within the predetermined time period selected). After this procedure the machine can be safely restarted.

JSHT1 A/B Electrical Connections

Connection for single channel input.

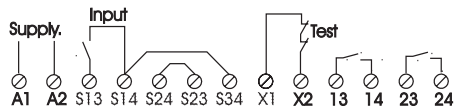

Connection for dual channel input.

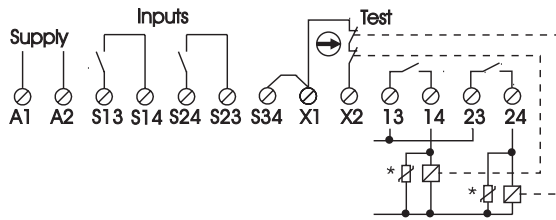

Selection of time by hardwire links.

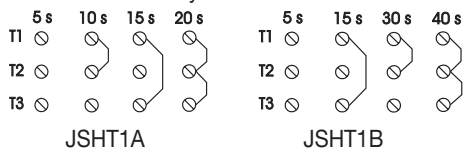

** It is recommended that all switched loads are adequately suppressed and/or fused in order to provide additional protection for the safety contacts.*

In the figure the monitoring of two contactors in the test input is shown.

JSHT2 A/B/C Safety Timer closes 2 independent relay outputs during a guaranteed maximum time when the inputs are closed

Time Bypassing

Sensors detect the autocarrier and are connected to the JSHT2 which supervises the sensors and bypasses the light beam for a maximum predetermined time.

Inching

Inching applications require safety outputs to be closed for a predetermined maximum period of time, allowing the machine to move only a short distance each time the inching control is activated. For each new motion the inching control, e.g. PB or pedal must be released and activated again.

Operation

When the inputs close the output contacts close. The output contacts open when the input opens or when the time period has expired. The time is hardwire selectable on the terminals T1, T2 and T3. The time given is the maximum time. Single or dual channel operation is also hardwire selectable.

Connection Examples

For examples of how our safety relays can solve various safety problems, see "Connection Examples" beginning on page 5:44.

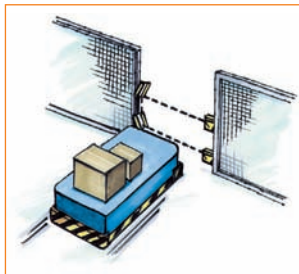

Light beam being bypassed only for the time it takes the autocarrier to pass.



Shaft only turns a small amount each time the PB is pressed.

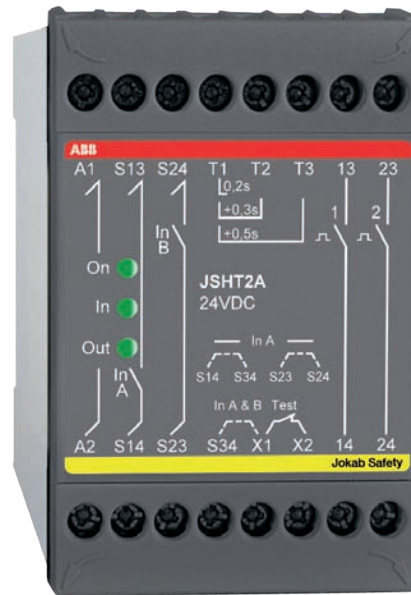

Applications

- Time Bypassing
- Inching

Features

- Hardwire time selection 0.2 - 40 s
- Selectable single or dual channel input
- Test input
- Width 45 mm
- LED indication for supply, inputs and outputs
- 1+1 NO relay outputs
- 24 VDC
- 24/48/115/230 VAC
- Quick release connector blocks

Regulations and Standards

The JSHT2 A/B/C is designed and approved in accordance with appropriate directives and standards. See Technical Data.

Approvals

TÜV Nord  

JSHT2 A/B/C Technical Data

Manufacturer	ABB AB/Jokab Safety, Sweden
Ordering information	see page 5:65
Color	Grey
Power supply	24 VDC ± 15 % 24/48/115/230 VAC ± 15 %, 50 - 60 Hz
Power consumption	1.8 W/3.8 VA
Max input wire res. at nom voltage/channel	100/200 Ohm (1 Channel/ 2 Channel)
Response time at activation	< 30 ms
Response time at deactivation	< 15 ms
Selectable time (± 15 % at nom. V.)	JSHT2A: 0.2 - 0.5 - 0.7 - 1.0 sec JSHT2B: 5 - 10 - 15 - 20 sec JSHT2C: 5 - 15 - 30 - 40 sec
Relay outputs	2 x 1 NO
Maximum switching capacity	4A/250 VAC/1000 VA AC15 250VAC 3A 4A/24 VDC/100 W DC13 24VDC 2A
Maximum total switching capacity	8A distributed on all contacts
Minimum load	10mA/10 V (if load on contact has not exceeded 100 mA)
Contact material	AgCuNi
Fuses output (external)	3A gL/gG or 4A fast
Maximum input wire res. at nom. voltage	100 Ohm
Terminals (max. screw torque 1 Nm)	Single strand Conductor with socket contact
Mounting	35 mm DIN-rail
Protection class	IP 20/IP 40 IEC 60529

Impulse withstand voltage	2.5kV
Pollution degree	2
Operating temperature range	-10°C to +55°C (with no icing or condensation)
Operating humidity range	35% to 85%
LED indication	Electrical Supply, Inputs, Outputs
Weight	24 VDC: 310 g 24/48/115/230 VAC: 410 g.
Performance (max.) Functional test The relays must be cycled at least once a year	Safety Category 4/PL e (EN ISO 13849-1:2008) SIL 3 (EN 62061:2005) PFH _d 4.42E-09
Conformity	2006/42/EC, 2006/95/EC 2004/108/EC EN 954-1:1996, EN 62061:2005 EN ISO 13849-1:2008

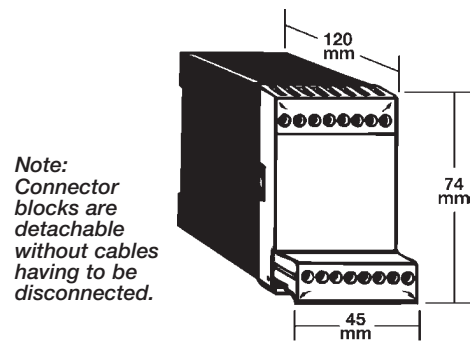

JSHT2 A/B/C Technical Description

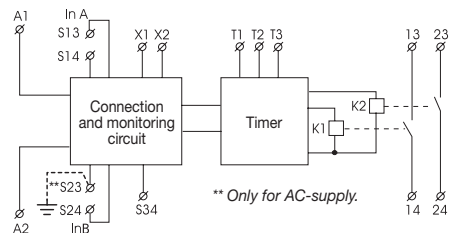

The electrical supply is connected across A1 and A2. The internal supervising circuit is activated directly when the supply is on. The inputs A and B must both be opened and then closed. Thereafter K1 and K2 are activated and the outputs close. K1 and K2 are activated for the hardwired selected time (set by connections on the terminals T1, T2 and T3) If there is a short circuit between the inputs or the inputs are

opened again before the set time period has expired the outputs will open. In order to close the outputs again both the inputs have to be opened and both internal relays K1 and K2 deactivated (controlled by the supervising circuit) and the inputs again closed. By external hardware connections the JSHT2 can be made single or dual channel input. See figure below.

JSHT2 A/B/C Electrical Connections

Connection for single channel input.

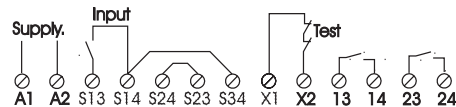

Connection for dual channel input.

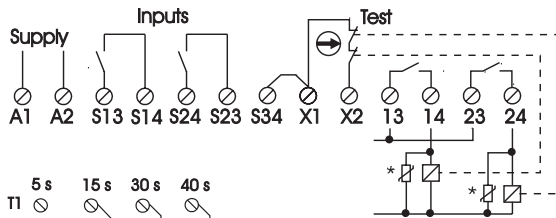

Selection of time by hardwire links.

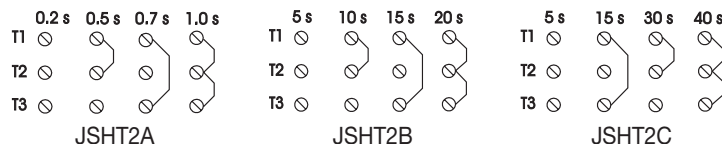

* It is recommended that all switched loads are adequately suppressed and/or fused in order to provide additional protection for the safety contacts.

In the figure the monitoring of two contactors in the test input is shown.

E1T Expansion Relay

More Outputs

By connecting expansion relays to a safety relay it is easy to increase the number of safe outputs. This means that an unlimited number of dangerous machine operations and functions can be stopped from one safety relay/PLC.

Safe Soft Stop

When a gate is opened a program stop is first given to the machine's PLC/servo which brakes the dangerous operations in a soft and controlled way. The safety outputs then break the power to the motors, that is, when the machine has already stopped. Normally between 0.5 and 1 second is needed to brake a dangerous machine operation softly. Soft stop ensures many advantages:

- The machine lasts longer.
- Parts being processed are not damaged.
- Restart from stopped position is enabled and simplified.

A safe soft stop is achieved by means of a safety relay which gives the program stop, and an expansion relay, E1T, which gives safe delayed stop signals. See chapter "Connection Examples". The drop time delay on a E1T can be from 0 to 3 seconds depending on the model. By connecting several E1Ts in series even longer times can be achieved.

Safety Level

The E1T has twin stop functions, that is, two relays with mechanically operated contacts. A monitored stop function is achieved by connecting the test output (terminals X1 and X2) to the test or reset input on the safety relay which is being expanded.

One condition for a safe delayed stop is that the delay time cannot increase in the event of a fault. The E1T complies with this requirement.

When are delayed safe stops used?

Delayed safety stop signals can be used for emergency stops according to EN ISO 13850:2008 § 4.1.4. Stop category 1 and NFPA 79, i.e. a controlled stop with power to the actuator(s) available to achieve the stop and then removal of power when stop is achieved.

Stop category 1 may also be permitted when it is not possible to gain physical access to the machine before the safe stop is affected e.g:

- Gates, access time is normally over 1 sec.
- Covers and gates which are locked until dangerous operations and functions have been stopped.
- Long distances between a safety device and a dangerous machine function.



Applications

- More Safety Outputs
- Delayed Safety Outputs
- Output Contact Indication

Features

- Width 22.5 mm
- LED indication of output
- 4 NO relay outputs
- 24 VDC
- Single or dual channel operation option
- Quick release connector blocks

Connection Examples

For examples of how our safety relays can solve various safety problems, see "Connection Examples" beginning on page 5:44.

Regulations and Standards

The E1T is designed and approved in accordance with appropriate directives and standards. See Technical Data.

Approvals

TÜV Nord  

E1T Technical Data

Manufacturer	ABB AB/Jokab Safety, Sweden	Mounting	35 mm DIN-rail
Ordering information	see page 5:65	Protection class	
Color	Grey	Enclosure	IP 40 IEC 60529
Operational voltage	24 VDC ± 15%	Terminals	IP 20 IEC 60529
Power consumption	1.5 W	Impulse withstand voltage	2.5kV
Relay outputs	4 NO	Pollution degree	2
Maximum switching capacity		Operating temperature range	-10°C – +55°C (with no icing or condensation)
Resistive load AC	6A/250VAC/1500VA	Operating humidity range	35% to 85%
Inductive load AC	AC15 240VAC 2A	LED indication	Output status
Resistive load DC	6A/24VDC/150W	Weight	220 g
Inductive load DC	DC13 24VDC 1A	Performance (max.)	Category 4/PL e (EN ISO 13849-1:2008)
Max. total switching capacity	12A distributed on all contacts	Functional test	SIL 3 (EN 62061:2005)
Minimum switching load	10 mA/10 V (if load on contact has not exceeded 100 mA)	The relays must be cycled at least once a year	PFH _d 1.55E-08
Contact material	Ag + Au flash	Conformity	2006/42/EC, 2006/95/EC 2004/108/EC EN 954-1:1996, EN 62061:2005 EN ISO 13849-1:2008
Fuses output (external)	5A gL/gG		
Conditional short-circuit current (1 kA)	6A gG		
Maximum external resistance at nominal voltage	150 Ohm (S14, S24)		
Response time at deactivation (input-output)	< 0,020 s, 0,5 s, 1 s, 1,5 s, 2 s, 3 s, ± 20%		
Response time at activation (input-output)	<30 ms		
Terminals (max. screw torque 1 Nm)			
Single strand	1x4 mm ² /2x1.5 mm ²		
Conductor with socket contact	1x2.5 mm ² /2x1 mm ²		

Note:
Connector blocks are detachable without cables having to be disconnected.

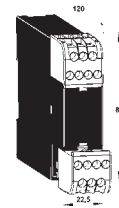

E1T Technical Description

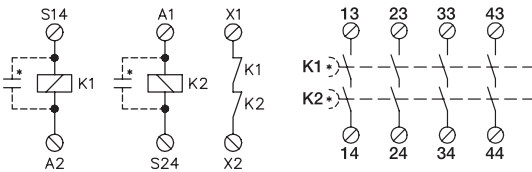

operation - see below.) When the inputs S14 and S24 close, relays K1 and K2 are activated. A stop signal is given, K1 and K2 drop, if the inputs are opened or during power failure. K1 and K2 drop either directly or after a delay* (if incorporated). Delay time of module is fixed and shown on front panel of device. The delay circuit is arranged so that the design time cannot be exceeded.

X1 and X2 to the test or reset input on the safety relay which is expanded (see below). K1 and K2 are mechanically operated relays, therefore, if one of the output contacts should stick closed then the relay's contact in X1-X2 cannot be closed thus preventing a new ready signal being given to the safety relay.

The E1T has to be connected to a safety relay in order to fulfill the necessary safety requirements (see connection examples below). The safety relay controls and monitors the E1T. (The E1T can be connected for single or dual channel

To check that both the relays K1 and K2 drop during a stop signal they must be monitored. This is achieved by connecting

Inductive loads should be equipped with an arc suppressor to protect the output contacts.

Diodes are the best arc suppressors but will increase the switch off time of the load.

E1T Electrical Connections

Single channel expansion of outputs for a safety relay connected to an emergency stop.

Dual channel expansion with delayed safety outputs for a safety relay monitoring a gate.

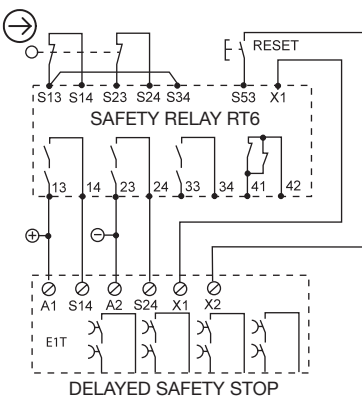
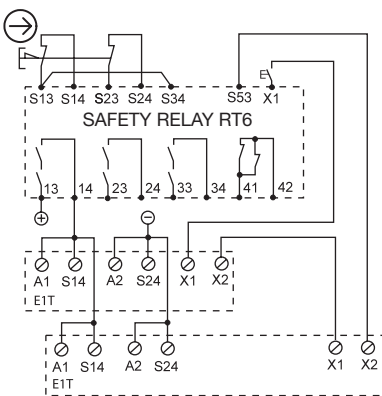

JSR1T Expansion Relay

More Outputs

By connecting expansion relays to a safety relay it is easy to increase the number of safe outputs. This means that an unlimited number of dangerous machine operations and functions can be stopped from one safety relay/PLC.

Safe Soft Stop

When a gate is opened, a program stop is first given to the machine's PLC/servo which brakes the dangerous operations in a soft and controlled way. The safety outputs then break the power to the motors, that is, when the machine has already stopped. Normally between 0.5 and 1 second is needed to brake a dangerous machine operation softly. Soft stop ensures many advantages:

- The machine lasts longer.
- Parts being processed are not damaged.
- Restart from stopped position is enabled and simplified.

A safe soft stop is achieved by means of a safety relay which gives the program stop, and an expansion relay, JSR1T, which gives safe delayed stop signals. See chapter "Connection Examples". The drop time delay on a JSR1T can be from 0 to 10 seconds depending on the model. By connecting several JSR1Ts in series even longer times can be achieved.

Safety Level

The JSR1T has twin stop functions, that is, two relays with mechanically operated contacts. A monitored stop function is achieved by connecting the test output (terminals X1 and X2) to the test or reset input on the safety relay which is being expanded.

One condition for a safe delayed stop is that the delay time cannot increase in the event of a fault. The JSR1T complies with this requirement.

When are delayed safe stops used?

Delayed safety stop signals can be used for emergency stops according to EN ISO 13850:2008 § 4.1.4. Stop category 1 and NFPA 79, i.e. a controlled stop with power to the actuator(s) available to achieve the stop and then removal of power when stop is achieved.

Stop category 1 may also be permitted when it is not possible to gain physical access to the machine before the safe stop is affected e.g:

- Gates, access time is normally over 1 sec.
- Covers and gates which are locked until dangerous operations and functions have been stopped.
- Long distances between a safety device and a dangerous machine function.



Expansion Relay with

- More Safety Outputs
- Delayed Safety Outputs
- Information Output

Features

- Width 45 mm
- LED indication of output
- 4 NO/1 NC relay outputs
- 24 VDC
- Single and dual channel
- Quick release connector blocks

Connection Examples

For examples of how our safety relays can solve various safety problems, see "Connection Examples" beginning on page 5:44.

Regulations and Standards

The JSR1T is designed and approved in accordance with appropriate directives and standards. See Technical Data.

Approvals

TÜV Nord  

JSR1T Technical Data

Manufacturer	ABB AB/Jokab Safety, Sweden
Ordering information	see page 5:66
Color	Grey
Power supply	24 VDC ±15%
Power consumption	1.2 W
Relay outputs	4 NO + 1 NC
Max. switching capacity	
Resistive load AC	6A/250 VAC/1500 VA
Inductive load AC	AC15 240VAC 2A
Resistive load DC	6A/24 VDC/150 W
Inductive load DC	DC13 24VDC 1A
Max. total switching capacity	16A distributed on all contacts
Minimum load	10mA/10 V (if load on contact has not exceeded 100 mA)
Contact material	Ag + Au flash
Fuses output (external)	5A gL/gG
Conditional short-circuit current (1 kA)	6A gG
Maximum input wire res. at nom. voltage	150 Ohm (S14, S24)
Response time at deactivation (input-output)	< 0,020 s, 0,5 s, 1 s, 1,5 s, 2 s, 3 s, 5 s, 8 s, 10 s ± 20 %
Terminals (max. screw torque 1 Nm)	
Single strand	1 x 2.5 mm ² /2 x 1mm ²
Conductor with socket contact	1 x 4 mm ² /2 x 1.5 mm ²
Mounting	35 mm DIN-rail

Impulse withstand voltage	2.5kV
Protection class	
Enclosure/Terminals	IP 40/20 IEC 60529
Pollution degree	2
Operating temperature range	-10°C to +55°C (with no icing or condensation)
Operating humidity range	35% to 85%
LED indication	Output Relay Supplies
Weight	280 g
Performance (max.)	Category 4/PL e
Functional test	(EN ISO 13849-1:2008)
The relays must be cycled at least once a year	SIL 3 (EN 62061:2005) PFH _d 1.55E-08
Conformity	2006/42/EC, 2006/95/EC 2004/108/EC EN 954-1:1996, EN 62061:2005 EN ISO 13849-1:2008

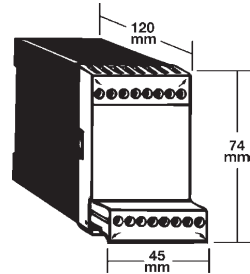

Note:
Connector blocks are detachable without cables having to be disconnected.

JSR1T Technical Description

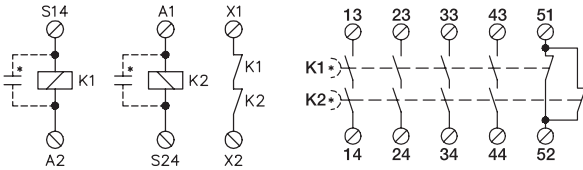

The JSR1T has to be connected to a safety relay in order to fulfill the necessary safety requirements (see connection examples below). The safety relay controls and monitors the JSR1T. (The JSR1T can be connected for single or dual channel

operation - see below.)
When the inputs S14 and S24 close, relays K1 and K2 are activated. A stop signal is given, if the inputs are opened or during power failure. K1 and K2 drop either directly or after a delay* (if incorporated). Delay time of module is fixed and shown on front panel of device. The delay circuit is arranged so that the design time cannot be exceeded.

To check that both the relays K1 and K2 drop during a stop signal they must

be monitored.

This is achieved by connecting X1 and X2 to the test or reset input on the safety relay which is expanded (see below). K1 and K2 are mechanically operated relays, therefore, if one of the output contacts should stick closed then the relay's contact in X1-X2 cannot be closed thus preventing a new ready signal being given to the safety relay.

Inductive loads should be equipped with an arch suppressor to protect the output contacts.

Diodes are the best arc suppressors but will increase the switch of time of the load.

JSR1T Electrical Connections

Expansion of outputs for safety relay connected to emergency stop with automatic reset.

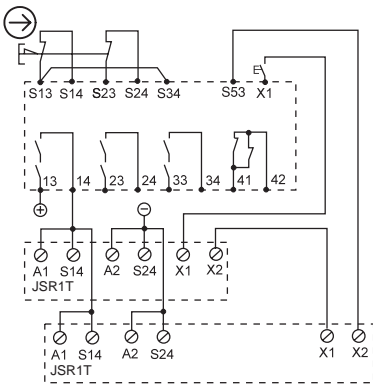

Dual channel expansion with delayed safety outputs for a safety relay monitoring a gate.

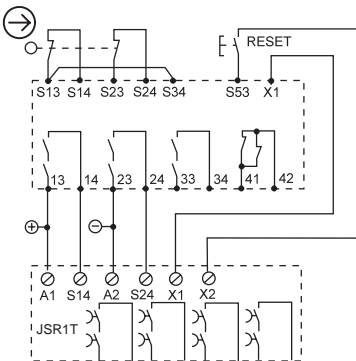

JSR2A Expansion Relay

More Outputs

The JSR2A expansion relay is used to provide increased switching capacity and number of safety outputs to a safety relay. This means that an unlimited number of dangerous machine operations and functions can be stopped from one safety relay/PLC.

Greater Current Switching Capacity

The JSR2A expansion relay enables switching of up to 10 amps (AC/DC) per output contact.

Safety Level

The JSR2A has twin stop functions, that is, two relays with mechanically positively guided contacts. A monitored stop function is achieved by connecting the test output (terminals X1 and X2) to the test or reset input on the safety relay which is to be expanded.

Connection Examples

For examples of how our safety relays can solve various safety problems, see “Connection Examples” beginning on page 5:44.



Expansion Relay with

- More Safety Outputs
- Greater Current Switching Capacity
- Output Contact Indication

Features

- Switching up to 10A/250V/output
- Width 45 mm
- LED function indication
- 4 NO/1 NC relay outputs
- 5 supply versions
- 24 VDC/VAC
- 48, 115, 230 VAC
- Quick release connector blocks

Regulations and Standards

The JSR2A is designed and approved in accordance with appropriate directives and standards. See Technical Data.

Approvals

TÜV Nord  

JSR2A Technical Data

Manufacturer	ABB AB/Jokab Safety, Sweden
Ordering information	see page 5:67
Color	Grey
Supply A1 - A2	24 VDC/AC, 48, 115, 230 VAC + 15%, 50-60 Hz
Power consumption	2.7W/2.4-4 VA
Relay outputs	4 NO + 1 NC
Maximum switching capacity	8A/230 VAC/1840 VA
Resistive load AC	10A/115VAC/48VAC/24VAC/1840 VA
Inductive load AC	AC15 230VAC 4A (NO-contact) 1.5A (NC-contact)
Resistive load DC	8A/24 VDC/192 W
Inductive load DC	DC13 24VDC 1.2A (NO/NC-contact)
Max. total switching capacity	16A distributed on all contacts
Min. load	10mA/10V/100mW (if load on contact has not exceeded 100 mA)
Contact material	AgSnO ₂ + Au flash
Fuses output (external)	6A gL (8A fast if short-circuit current >500A)
Conditional short-circuit current (1 kA)	10A gG
Max. input wire res. at nom. voltage	24 VDC/VAC: 100 Ohm 48/115/230 VAC: 200 Ohm
Mechanical operational life	>107 operations
Response time at deactivation (input-output)	<25 ms
activation (input-output)	<15 ms
Terminals (removable)	
Max. screw torque	1 Nm
Connection area (max.)	
Single strand	1 x 4 mm ² or 2 x 1.5 mm ² /12AWG
Conductor with socket contact	1 x 2.5 mm ² or 2 x 1 mm ²

Mounting	35 mm DIN-rail
Protection class	
Enclosure	IP 40 IEC 60529
Terminals	IP 20 IEC 60529
LED indication	
On	●
1	■ ● 1 ■ ● 2
2	
Impulse withstand voltage	2.5kV
Pollution degree	2
Operating temperature range	-10°C to +55°C (with no icing or condensation)
Operating humidity range	35% to 85%
Weight	313 g
Performance (max.)	Category 4/PL e (EN ISO 13849-1:2008)
Functional test	SIL 3 (EN 62061:2005)
The relays must be cycled at least once a year	PFH _d 1.55E-08
Conformity	2006/42/EC, 2006/95/EC 2004/108/EC EN 954-1:1996, EN 62061:2005 EN ISO 13849-1:2008

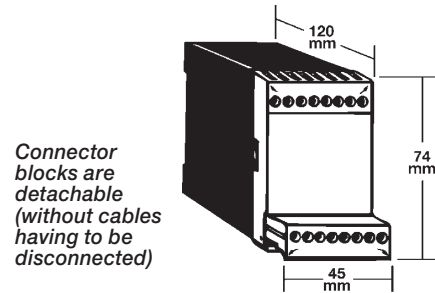

JSR2A Technical Description

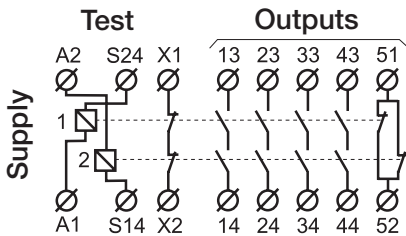

The JSR2A has to be connected to a suitable safety relay in order to fulfill the necessary safety requirements (see Connection Examples). The safety relay controls and monitors the JSR2A unit. (The JSR2A can be connected for single or dual channel operation — see electrical connection diagrams below.) When the inputs to S14 and S24 close, internal relays K1 and K2 are activated. A stop signal is given, K1 and K2 drop, if the inputs are opened or during power failure.

To check that both the K1 and K2 relays drop during a stop signal they must be monitored. This is achieved by connecting X1 and X2 to the test or reset input on the safety relay which is expanded. K1 and K2 have mechanically positively guided contacts, therefore if one of the output contacts should stick closed then the relay's contact in X1-X2 cannot be closed thus preventing a new ready signal being given to the safety relay.

JSR2A Electrical Connections

One channel expansion of RT6 with JSR2A connected for manual reset.

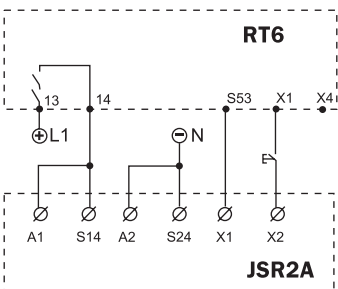

Dual channel expansion of RT6 with JSR2A connected for automatic reset.

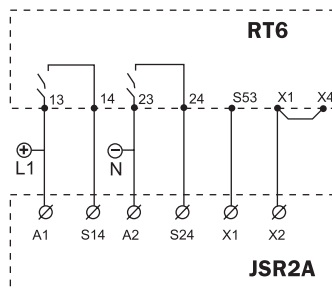

JSR3T Expansion Relay

Delayed Outputs

By connecting the JSR3T expansion relay to a compatible safety relay/PLC it is easy to obtain safe “delayed” outputs.

The JSR3T provides the system designer with the facility to hardwire selected time delays in steps between 0.5 and 10 seconds.

Use of Delayed Outputs

There are many applications where delayed outputs are necessary and permissible. For example delayed stop signals can be used for emergency stops according to EN ISO 13850:2008 § 4.1.4 Stop Category 1 and NFPA 79 (a controlled stop with power to the machine actuator(s) available to achieve the stop and then removal of power when stop is achieved). Stop Category 1 may also be permitted when it is not possible to gain physical access to the machine before the safe stop is effected, e.g. by:

- Covers and Gates which are locked until dangerous operations and functions have been stopped.
- Long distances between a safety device and dangerous machine functions.

Using this technique of stopping a machine provides many advantages i.e.:

- Machines last longer as they are not subjected to excessive loading, etc. when requested to stop.
- Parts being processed are not damaged.
- Restarting machines from stopped position is simplified.

A safe “soft” stop is achieved by means of a safety relay giving a programmed stop to the machine control system, e.g. when a gate is opened or emergency stop is activated. The output of the safety relay is used to provide both a stop signal to the machine control system, i.e. via a PLC which applies the necessary braking/stopping of the machine in a controlled way, and to switch a delayed expansion relay, e.g. JSR3T. The delayed safety outputs of the JSR3T expansion relay are then used to control the safe disconnection of the power to the actuators/motors, etc. of the machine.

Safety Level

The JSR3T has twin stop functions, using two positively guided contact relays. In order to achieve the level of monitoring required the JSR3T must be used with a suitable safety relay, e.g. JSBR4, RT6, RT9, etc. The JSR3T test output (terminals X1 and X2) must be connected to the test input of the safety relay being expanded. (See connection examples.)

The JSR3T provides delay times that even in the event of an internal fault condition complies with the requirement that the set delay cannot increase in time.



Expansion Relay with Delay for

- Hardwire Selection of Delay Time
- Delayed Safety Outputs

Features

- Hardwire selectable delay 0.5 - 10.0 seconds by hardwire links and time trim potentiometer
- Width 22.5 mm
- Output indication
- 2 x 1 NO relay outputs
- 24 VDC/VAC

Connection Examples

For examples of how our safety relays can solve various safety problems, see “Connection Examples” beginning on page 5:44.

Regulations and Standards

The JSR3T is designed and approved in accordance with appropriate directives and standards. See Technical Data.

Approvals

TÜV Nord  

JSR3T Technical Data

Manufacturer	ABB AB/Jokab Safety, Sweden
Ordering information	see page 5:67
Color	Grey
Power supply	24 VAC/DC, 50 - 60 Hz
Power consumption	1.3 VA/W
Relay outputs	2 x 1 NO (see connection examples)
Maximum switching capacity	
Resistive load AC	4A/250VAC/1000 VA
Inductive load AC	AC15 240VAC 3A
Resistive load DC	4A/24 VDC/100 W
Inductive load DC	DC13 24VDC 2A
Maximum res. load total switching capacity	6A distributed on all contacts
Minimum load	10mA/10V (if load on contact has not exceeded 100 mA)
Contact material	AgNi
Fuses output (external)	3A gL/gG or 4A fast
Conditional short-circuit current (1 kA)	6A gG
Max input wire res. at nom. voltage	100 Ohm
Response time at activation	<20ms
Response time at deactivation	<0.5 - 10.0 sec. at nom. voltage. Selected delay can be lowered by up to approx. 30% by means of preset potentiometer on front panel
Terminals (max. screw torque 1 Nm)	Single strand: 2x1.5 mm ² Conductor with socket contact: 2x1mm ²

Mounting	35 mm DIN-rail
Protection class	IP 40/20 IEC 60529
Enclosure/Terminals	IP 40/20 IEC 60529
Impulse withstand voltage	2.5kV
Pollution degree	2
Operating temperature range	-10°C to +55°C (with no icing or condensation)
Operating humidity range	35% to 85%
LED indication	Outputs
Weight	158 g
Performance (max.)	Category 4/PL e (EN ISO 13849-1:2008)
Functional test	SIL 3 (EN 62061:2005)
The relays must be cycled at least once a year.	PFH _d 3.67E-09
Conformity	2006/42/EC, 2006/95/EC 2004/108/EC EN 954-1:1996, EN 62061:2005 EN ISO 13849-1:2008

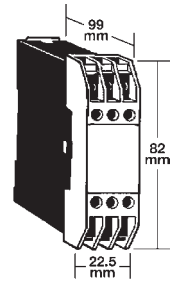

JSR3T Technical Description

When supply voltage is connected to A1 and A2, relays K1 and K2 are activated. When the supply voltage is removed, relays K1 and K2 remain energized for a time period determined by the hardwire link configuration chosen (set by connecting links on the terminals Y1, Y2, Y3 and Y4) and the setting of the Time Trim potentiometer.

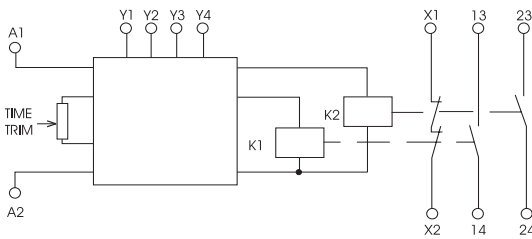

Note 1: Max. time set by hardwire links can only be reduced (up to approx. 40% reduction) by Time Trim potentiometer.

Note 2: Both the output contacts of K1 and K2 (13-14 and 23-24) must be used. Output contacts must be either connected in series (forming one safety output) or used in parallel circuits in order to obtain necessary redundancy.

JSR3T Electrical Connections

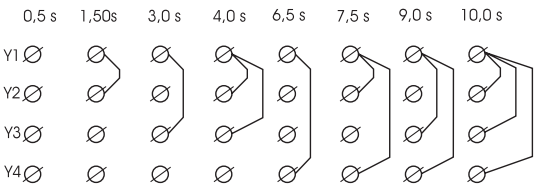
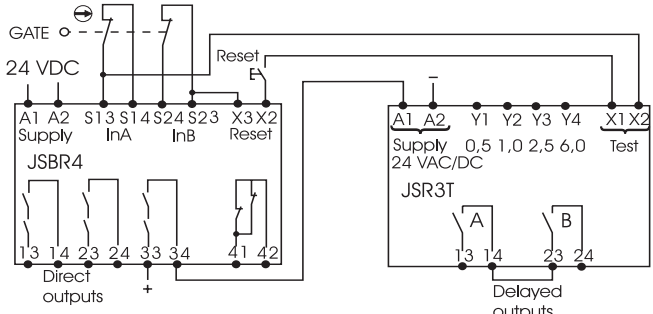
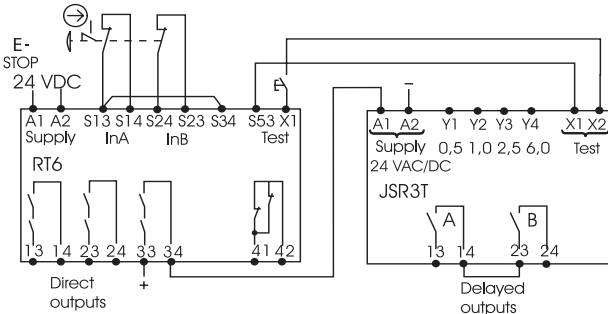

It is recommended that all switched loads are adequately suppressed and/or fused in order to provide additional protection for the safety contacts.

Selection of time delay by hardwire links (Y1, Y2, Y3 and Y4). Selected delay can be lowered by up to approximately 30% by means of preset potentiometer on front panel.

Connection Examples Contents

General Drawings - Relays

HA5400A	Connection Examples JSBR4.....	5:45
HA6400A	Connection Examples JSBT4.....	5:45
HA6500B	Connection Examples BT50.....	5:46
HA6501B	Connection Examples BT50T.....	5:46
HA6500C	Connection Examples BT51.....	5:47
HA6501C	Connection Examples BT51T.....	5:47
HA7100A	Connection Examples JSBRT11.....	5:48
HA7600A	Connection Examples RT6.....	5:48
HA7600B	Safety Mat, Emergency Stop, and Hatch with RT6.....	5:49
HA7672A	Enabling Device JSHD4-EX with RT6.....	5:49
HA7700A	Connection Examples RT7.....	5:50
HA7900A	Connection Examples RT9.....	5:50

Examples with Safety Light Beam

HE3811B	Safety Light Beam Spot with Time-Limited Reset.....	5:51
HE3824C	Light Beam with Time-Limited Bypass 0.2-40 s.....	5:51
HG7636B	Focus Light Grid/Curtain with Three-Position Device.....	5:52

Examples with Interlocked Doors/Switches

HG7611A	Interlocked Door with RT6 and Pre-Reset.....	5:52
HG7636A	Interlocked Door with Three-Position Device.....	5:53
HG7646A	Interlocked Door with Three-Position Device and Time-Limited Entrance/ Exit.....	5:53
HG7654A	Interlocked Door with RT6 and Output Expansion JSR1T.....	5:54

Examples with Interlocked Doors/Switches

HG7658A	Interlocked Door with RT6 and Output Expansion JSR2A.....	5:54
HG7673A	Safety Interlock Switch JSNY8 with RT6.....	5:55
HA6500A	Safety Interlock Switch JSBT5.....	5:55
HG7674A	Safety Interlock Switch JSNY9M/MLA with RT6.....	5:56
HG7674B	Safety Interlock Switch JSNY9S/SLA with RT6.....	5:56

Additional Examples

HH0000C	Three-Position Device JSHD4 with Various Safety Modules.....	5:57
HI8552A	Connection Example JSHT2 Intermittent Running.....	5:57

Safety Mats and Contact Strips

HK7600A	Safety Mat/Contact Strip with RT6.....	5:58
----------------	--	------

Hatches

HL7600B	Several JSNY7 Connected to one RT6 with Unique Indication.....	5:58
----------------	---	------

Magnetic Switches

HM0000A	Magnetic Switch JSNY7 with Various Safety Modules.....	5:59
----------------	---	------

Output Examples

HN7660A	Delayed Outputs RT6 with Output Expansion JSR3T/RT7.....	5:59
----------------	---	------

Common Examples

HP7600A	Machine Control - Isolation of PLC Inputs and Outputs.....	5:60
HP7600B	Machine Control - Isolation of PLC Outputs.....	5:60

Two-Hand Devices

HT5400A	Two-Hand Device with JSBR4.....	5:61
----------------	---------------------------------	------

General Drawing

HA5400A Connection Example JSBR4

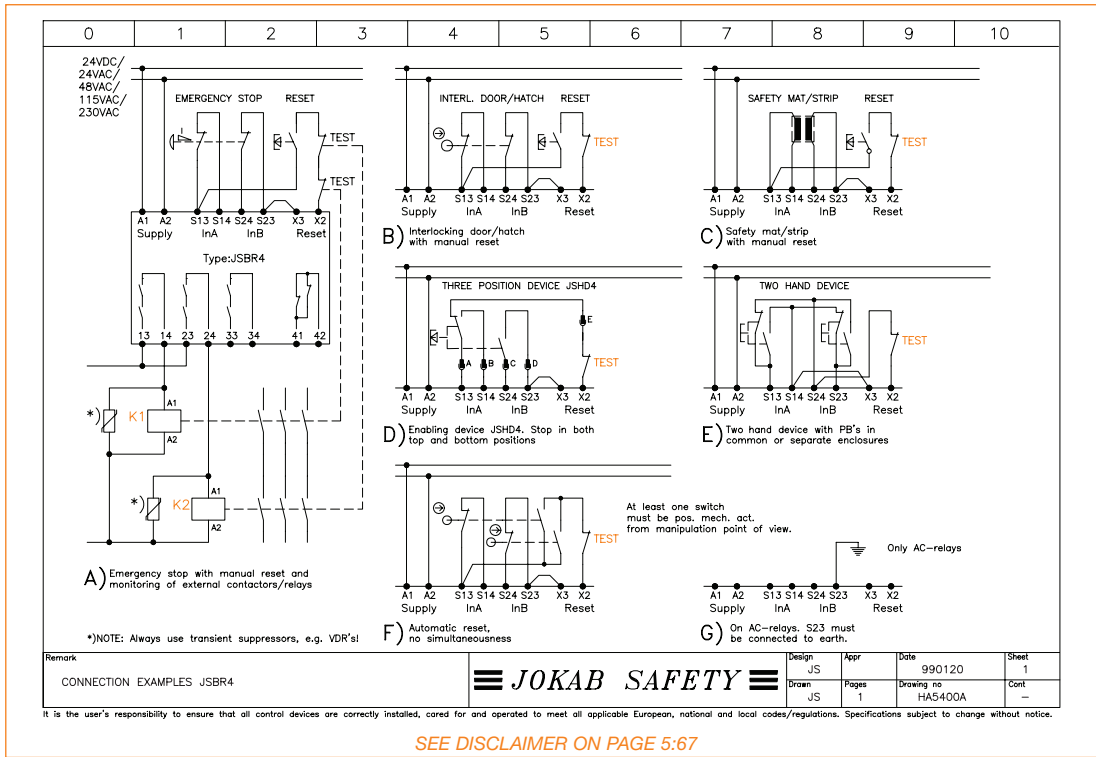

General Drawing

HA6400A Connection Example JSBT4

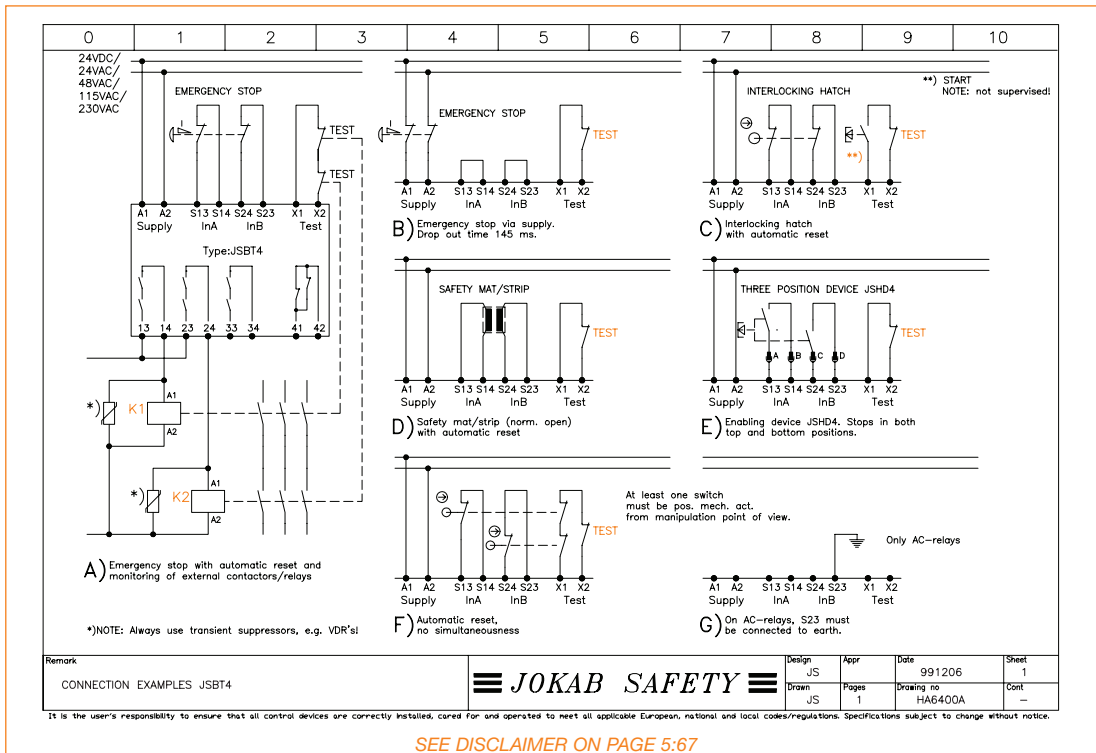

General Drawing

HA6500B Connection Example BT50

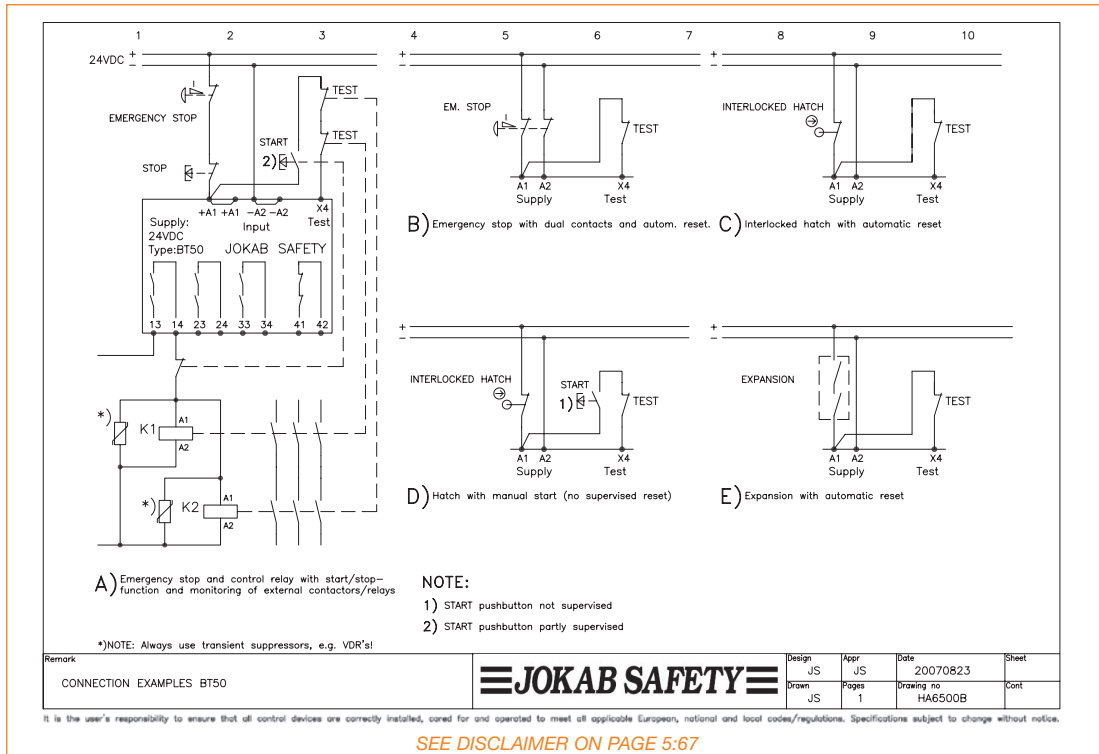

General Drawing

HA6501B Connection Example BT50T

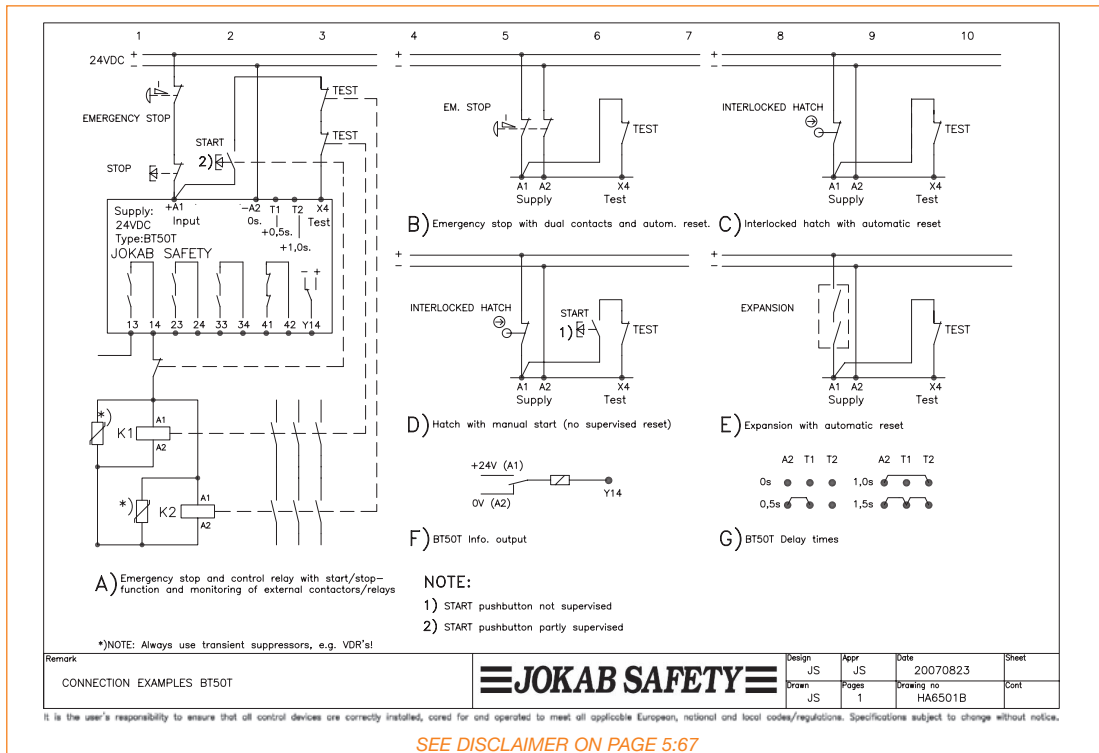

General Drawing

HA6500C Connection Example BT51

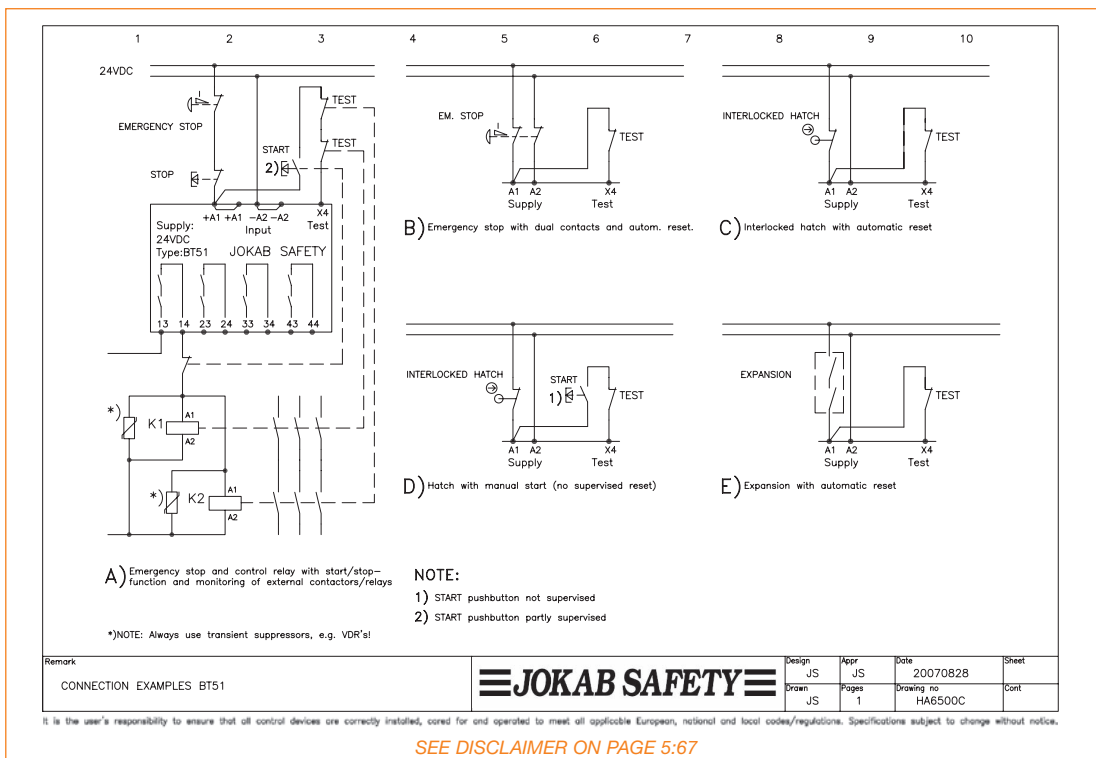

General Drawing

HA6501C Connection Example BT51T

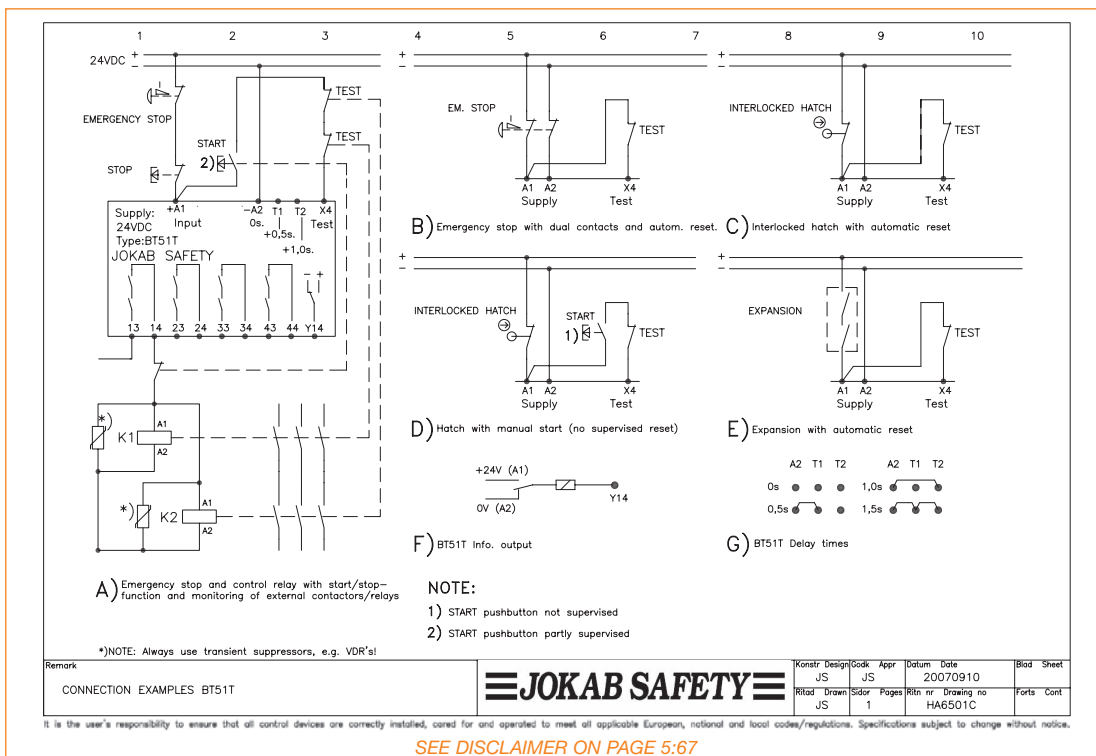

General Drawing

HA7100A Connection Example JSBRT11

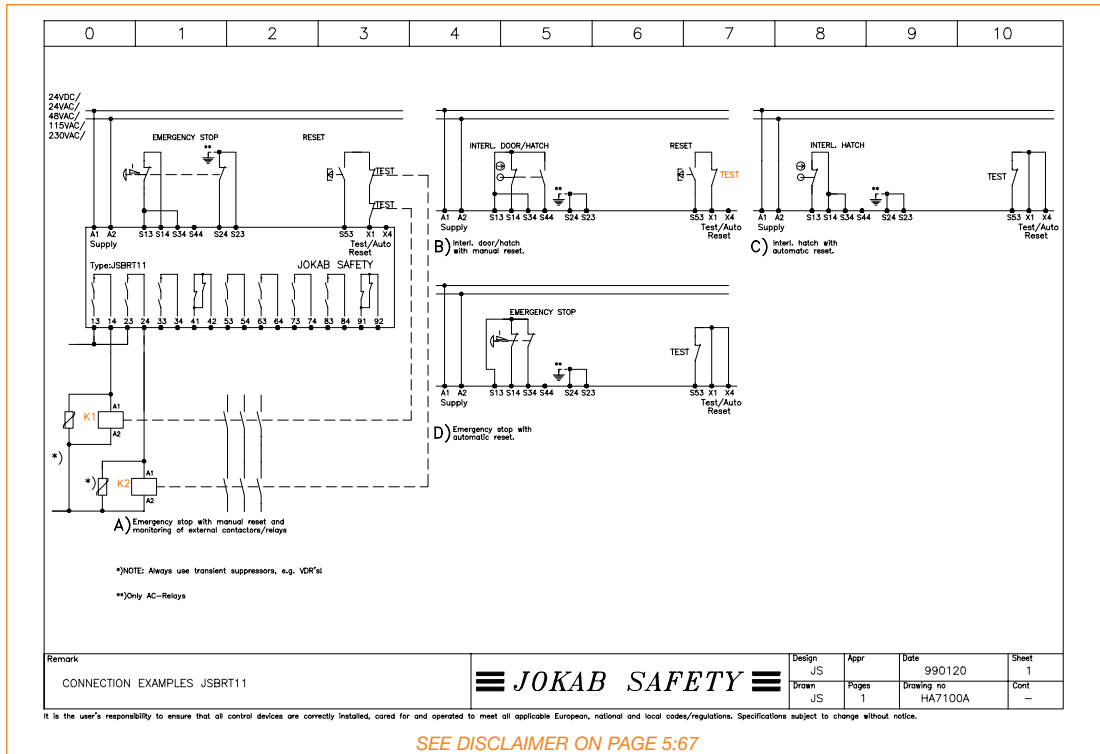

SEE DISCLAIMER ON PAGE 5:67

General Drawing

HA7600A Connection Example RT6

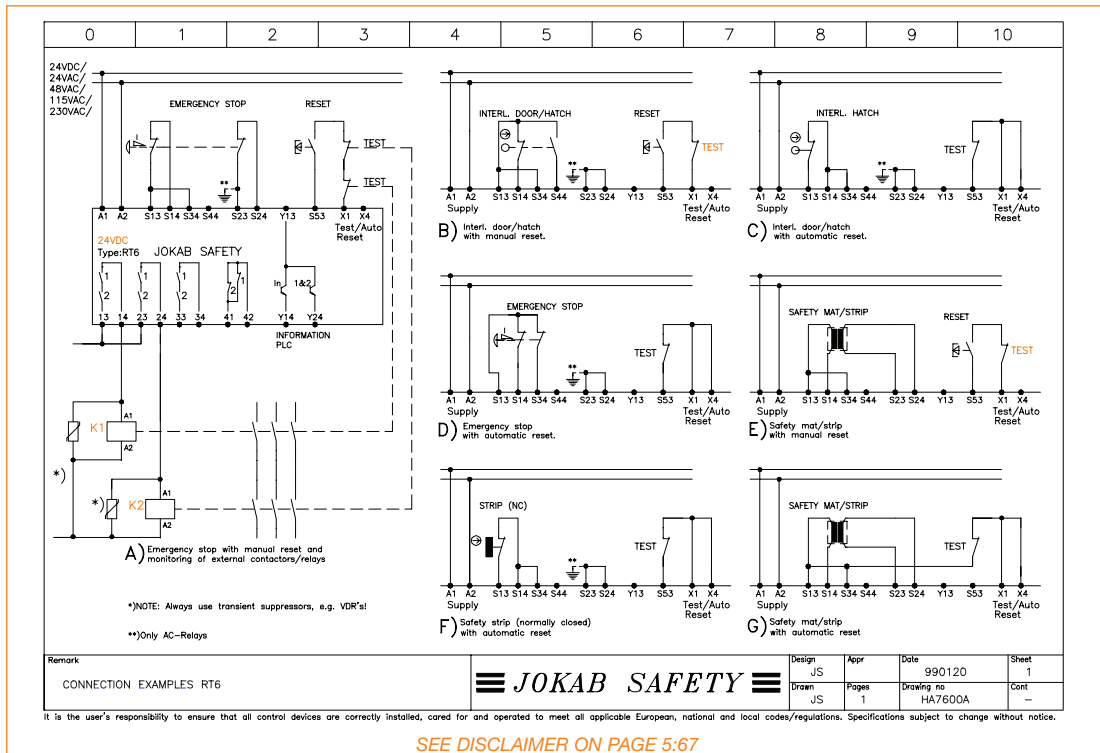

SEE DISCLAIMER ON PAGE 5:67

General Drawing

HA7600B Safety Mat, Emergency Stop and Hatch with RT6

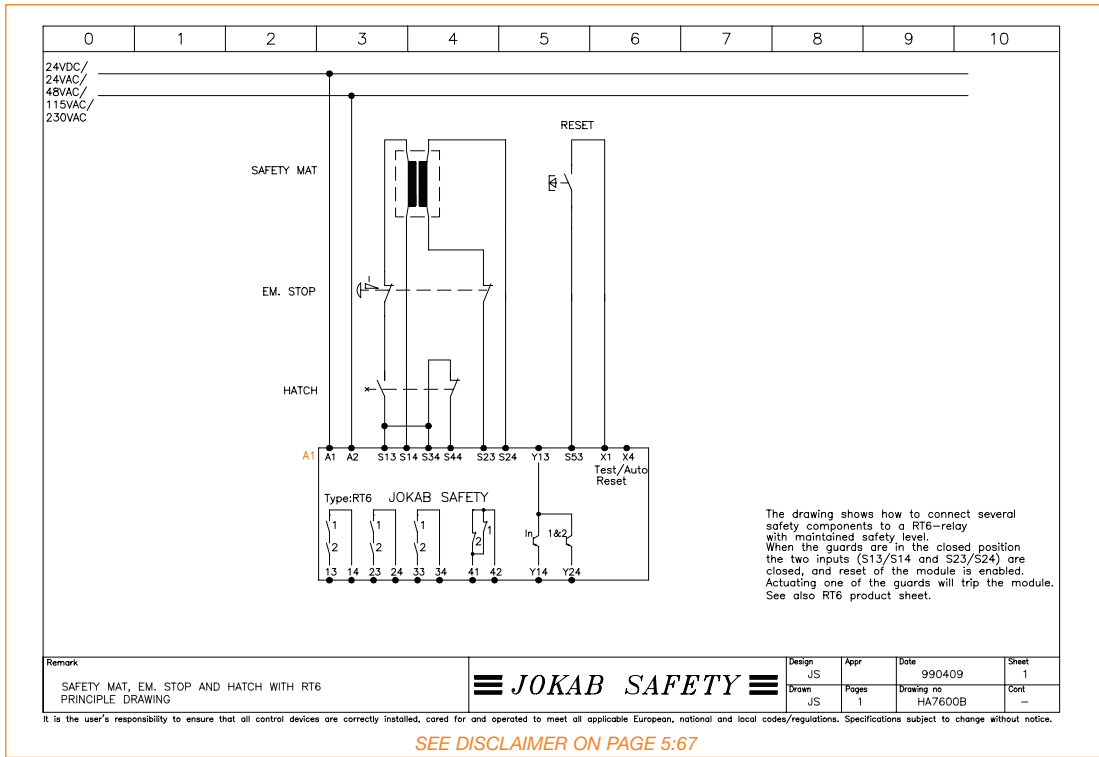

General Drawing

HA7672A Enabling Device JSHD4-EX with RT6

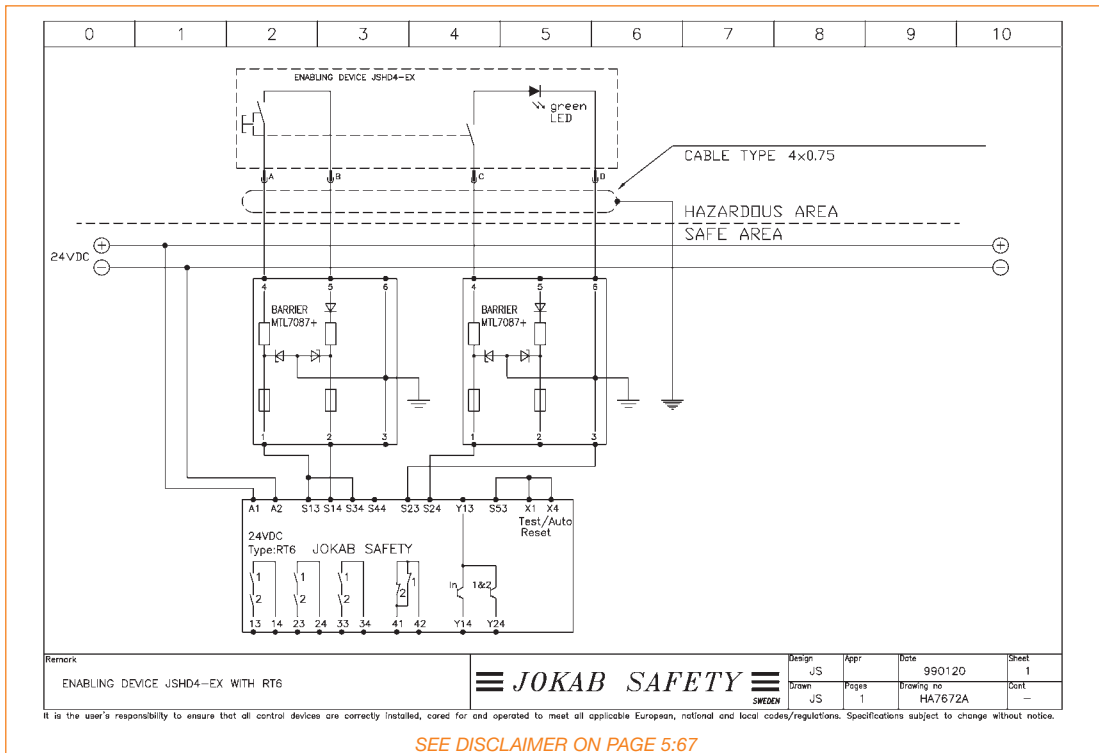

General Drawing

HA7700A Connection Example RT7

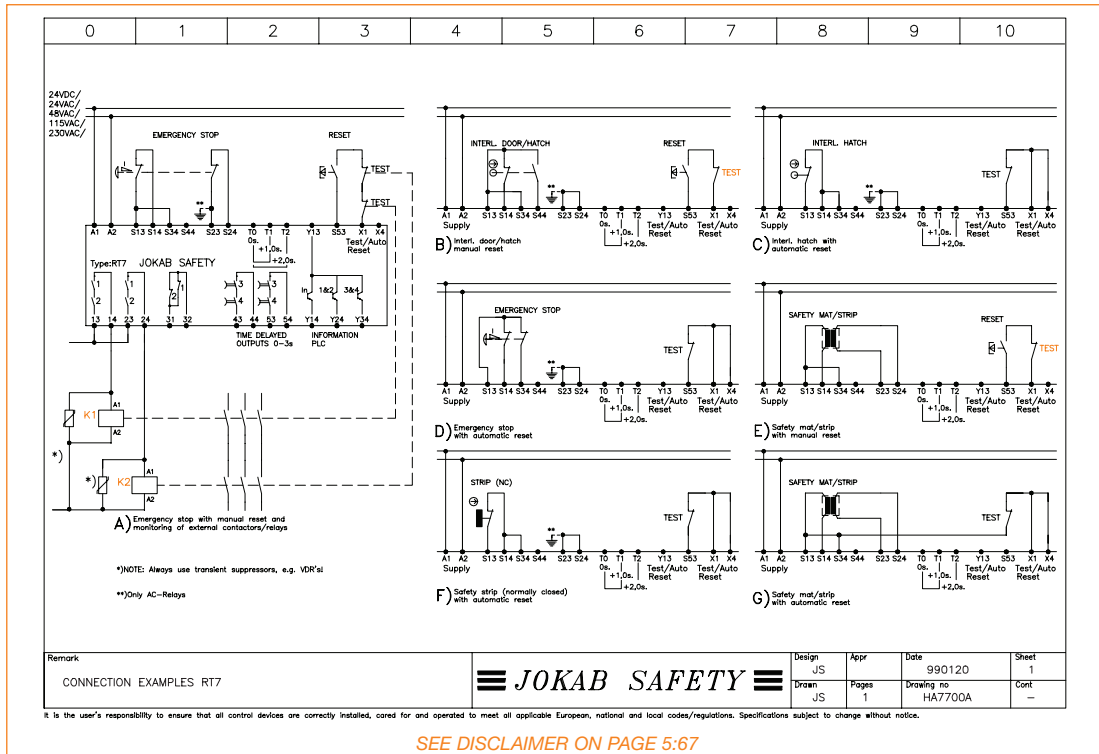

General Drawing

HA7900A Connection Example RT9

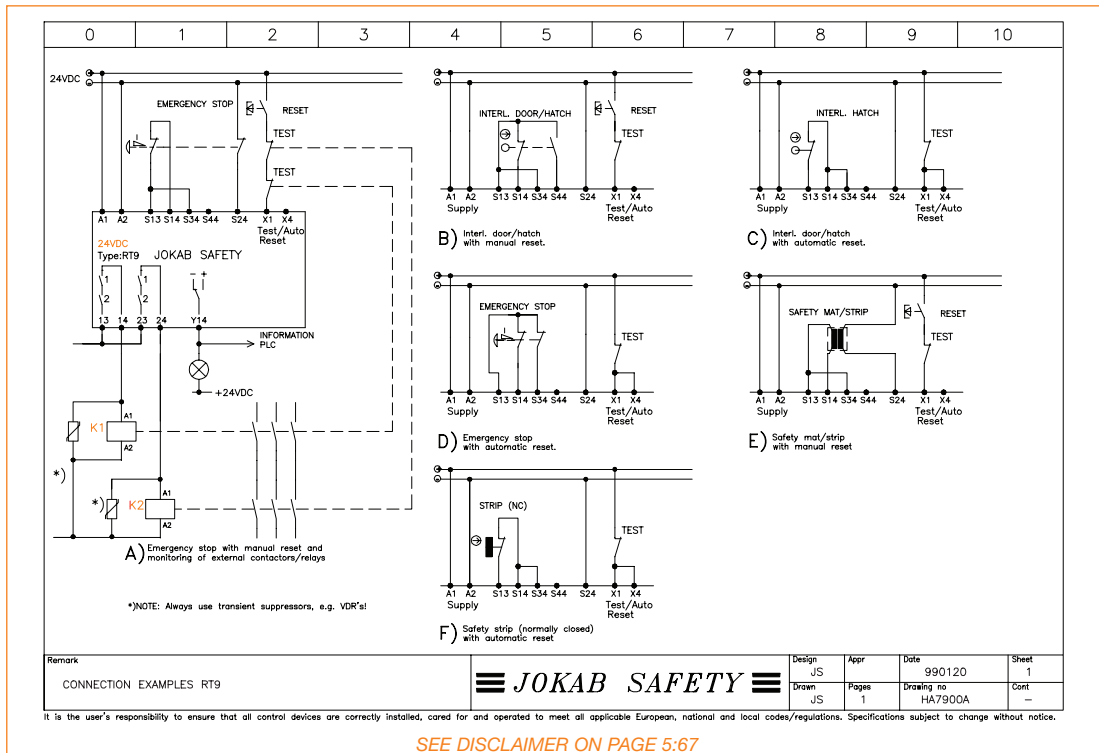

Example with Safety Light Beam

HE3811B Safety Light Beam Spot with Time-Limited Reset

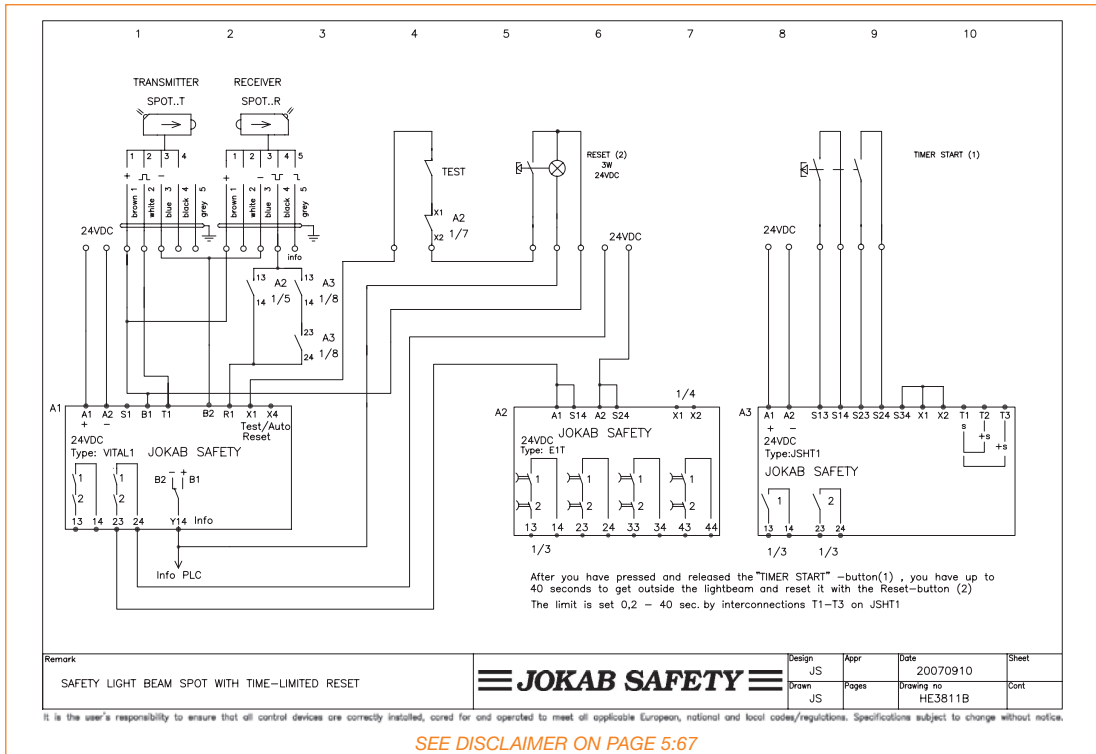

Example with Safety Light Beam

HE3824C Light Beam with Time-Limited Bypass 0.2-40 s

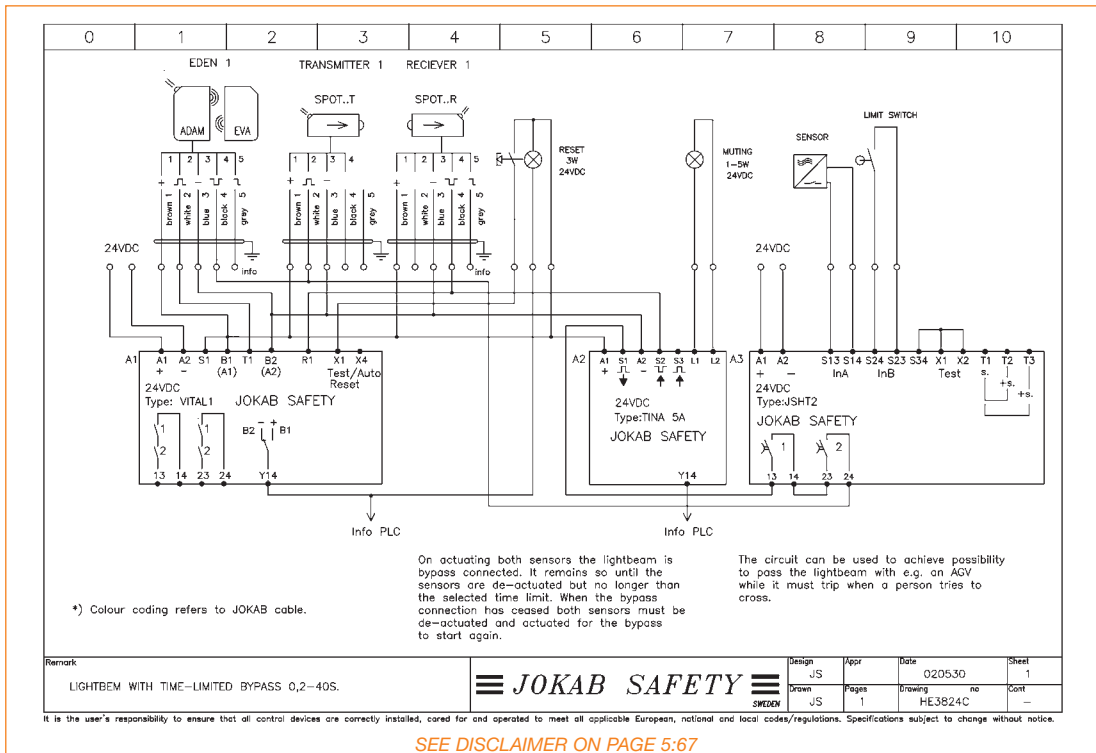

Example with Safety Light Beam

HG7636B Focus Light Grid/Curtain with Three-Position Device

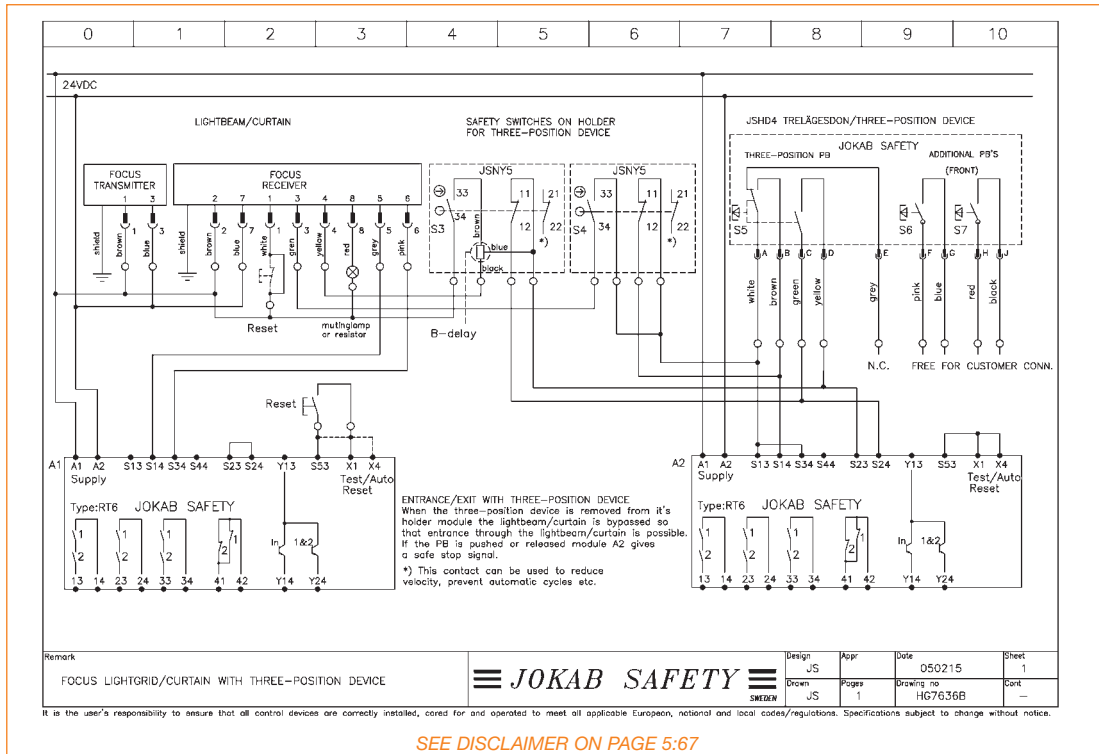

Example with Interlocked Doors/Switches

HG7611A Interlocked Door with RT6 and Pre-Reset

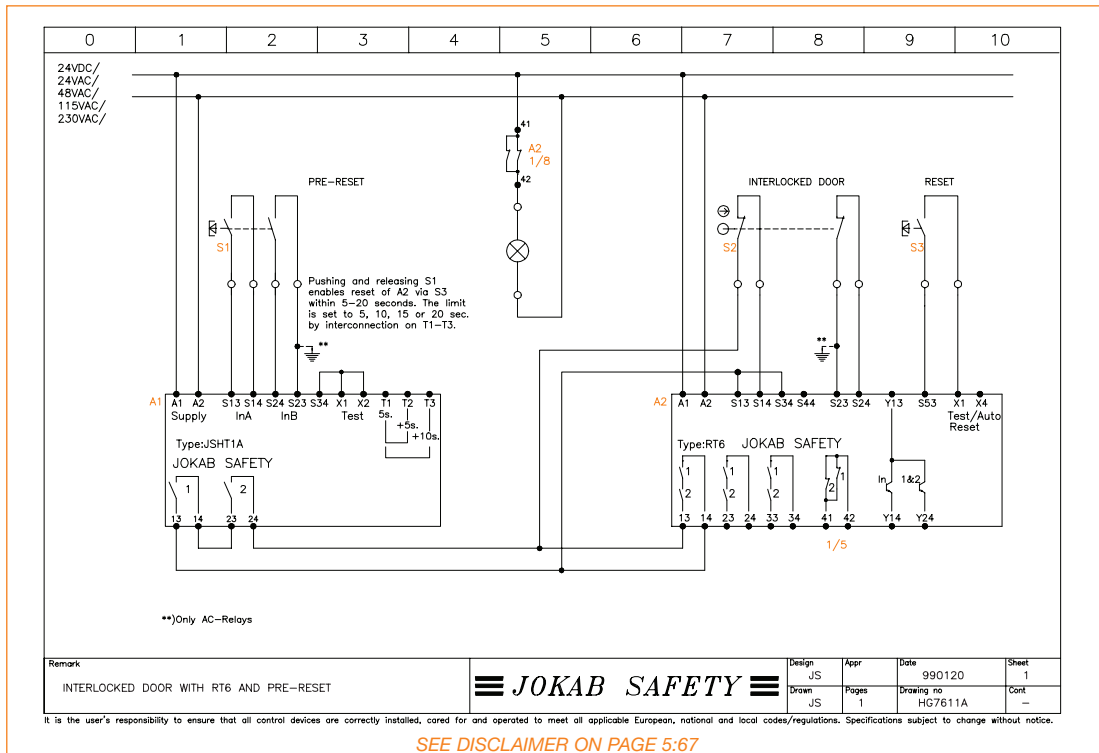

Example with Interlocked Doors/Switches

HG7636A Interlocked Door with Three-Position Device

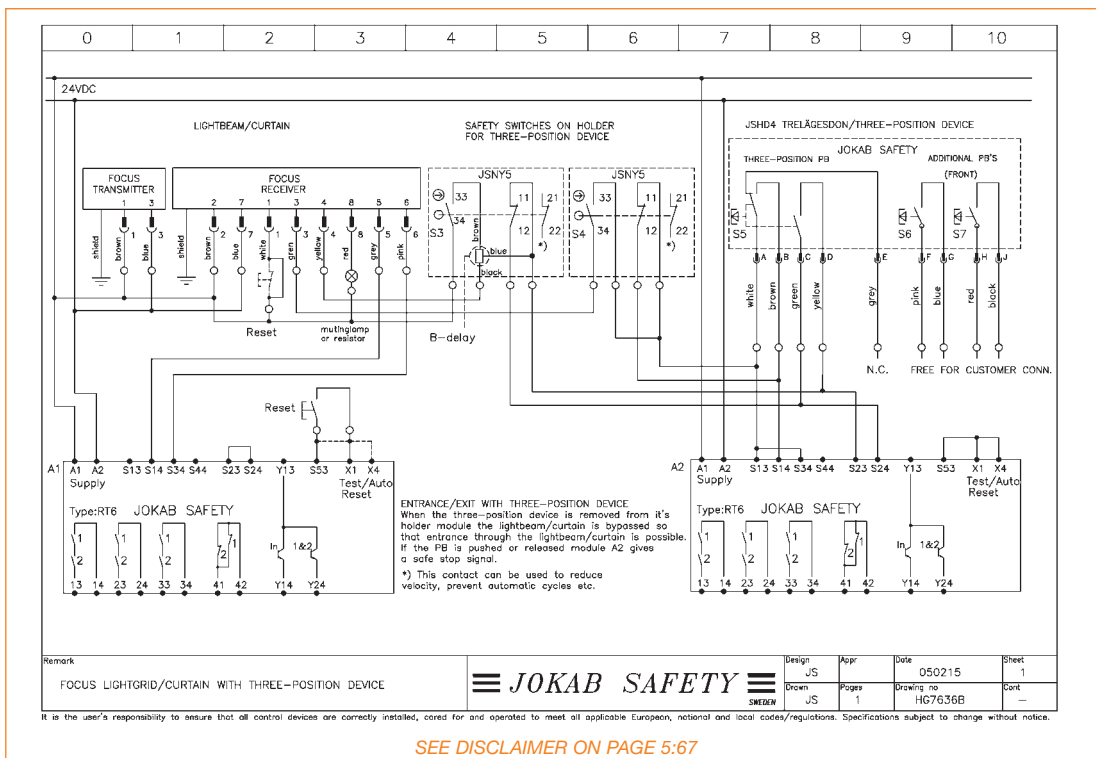

Example with Interlocked Doors/Switches

HG7646A Interlocked Door with Three-Position Device and Time-Limited Entrance/Exit

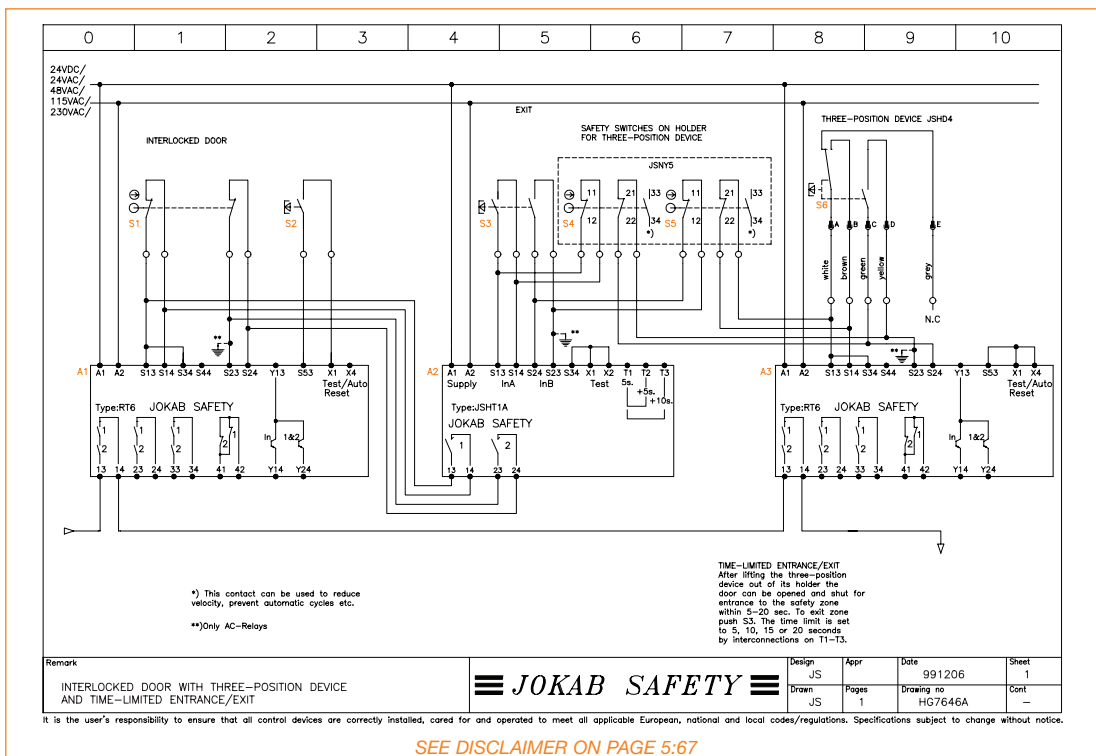

Example with Interlocked Doors/Switches

HG7654A Interlocked Door with RT6 and Output Expansion JSR1T

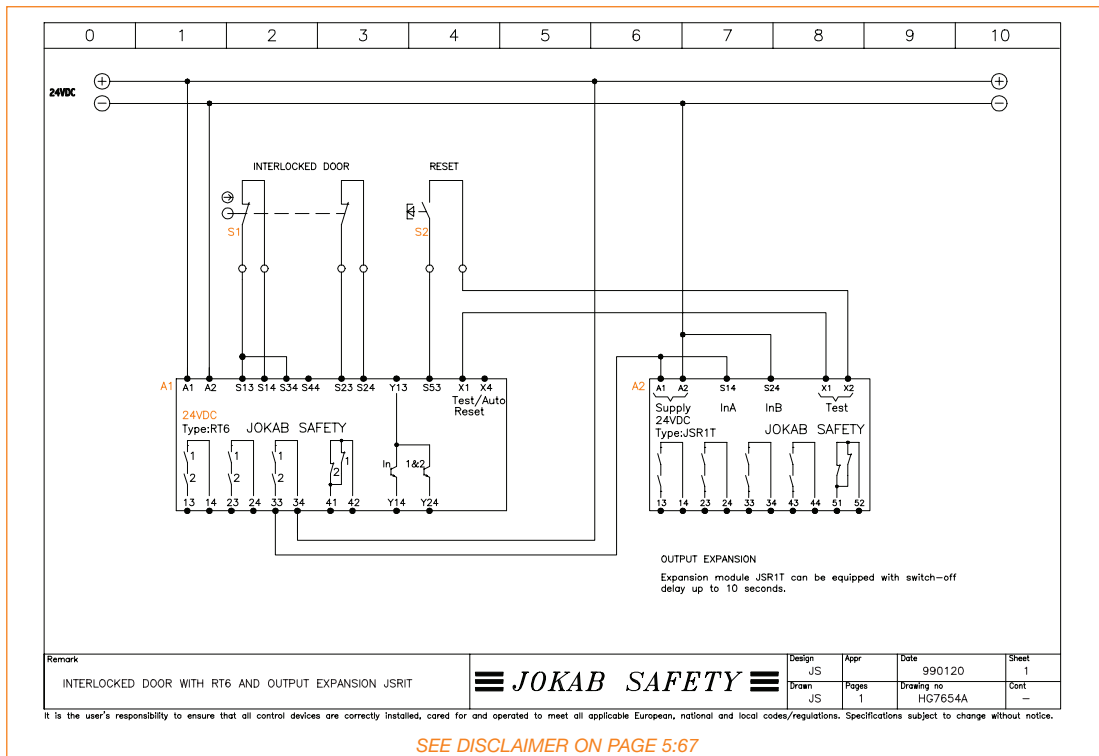

Example with Interlocked Doors/Switches

HG7658A Interlocked Door with RT6 and Output Expansion JSR2A

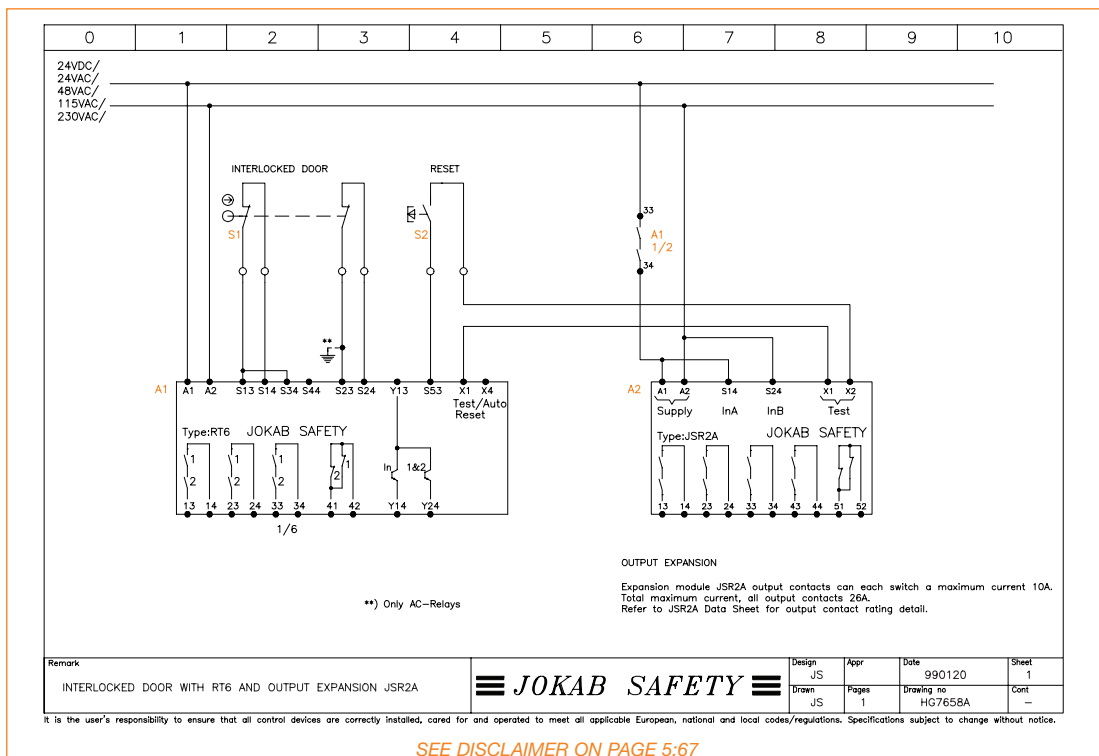

Example with Interlocked Doors/Switches HG7673A Safety Interlock Switch JSNY8 with RT6

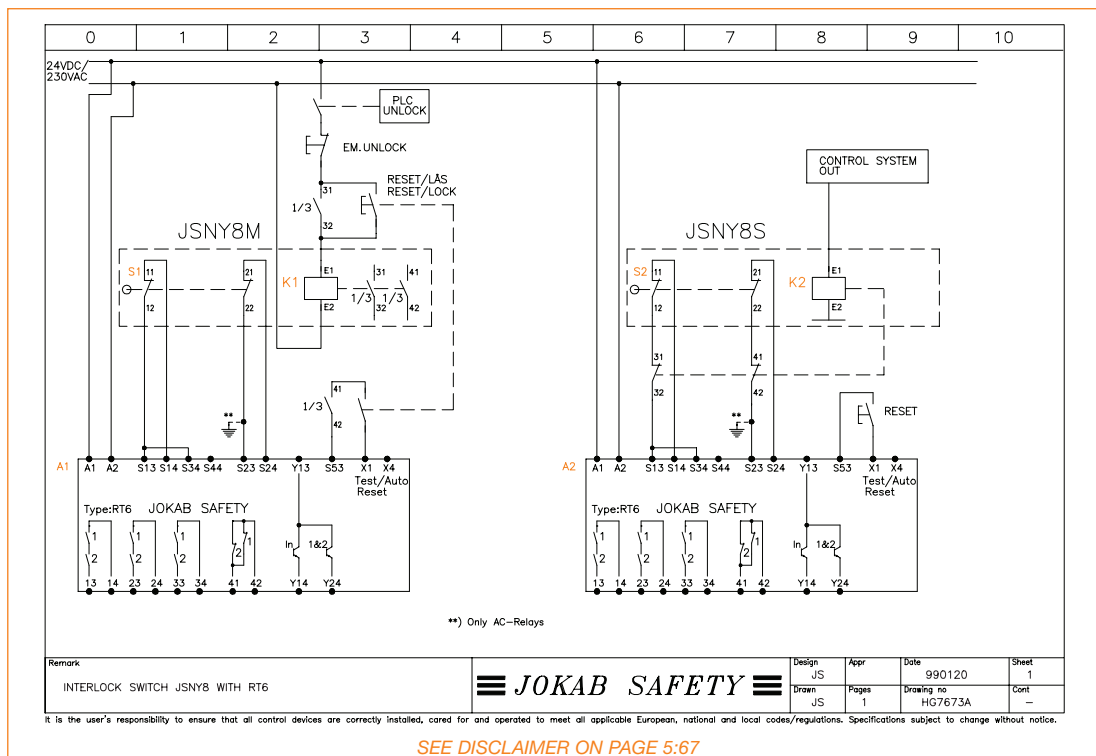

Example with Interlocked Doors/Switches HA6500A Safety Interlock Switch JSBT5

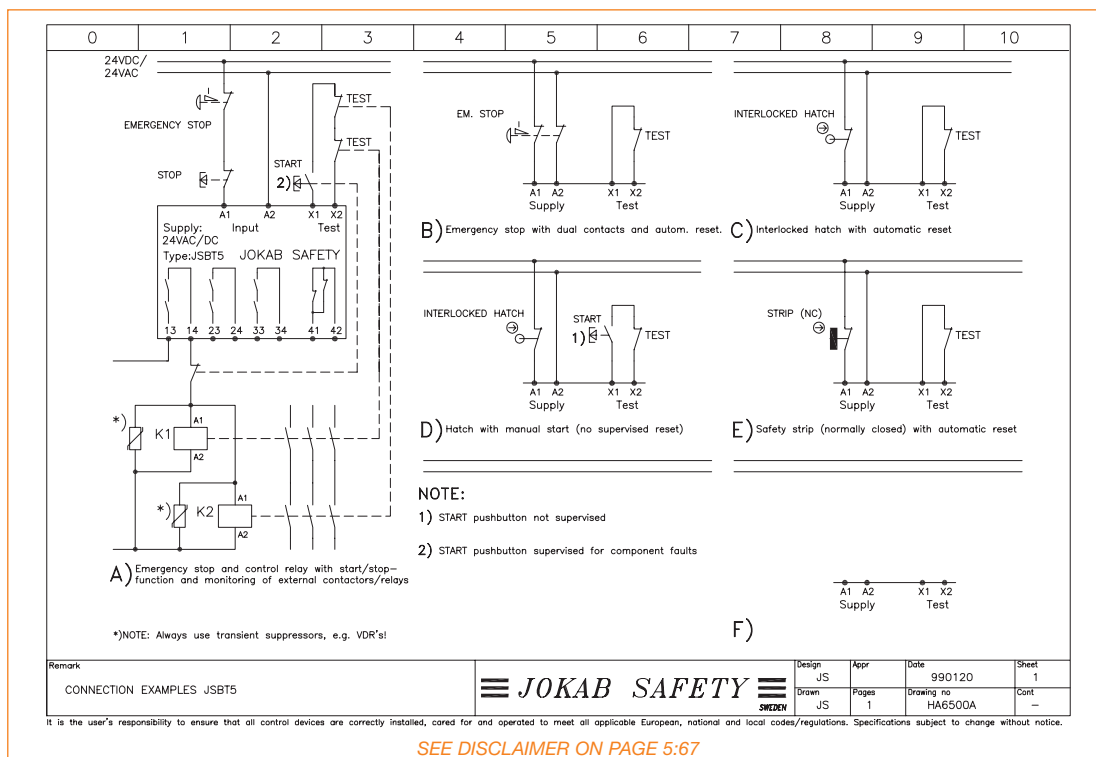

Example with Interlocked Doors/Switches

HG7674A Safety Interlock Switch JSNY9M/MLA with RT6

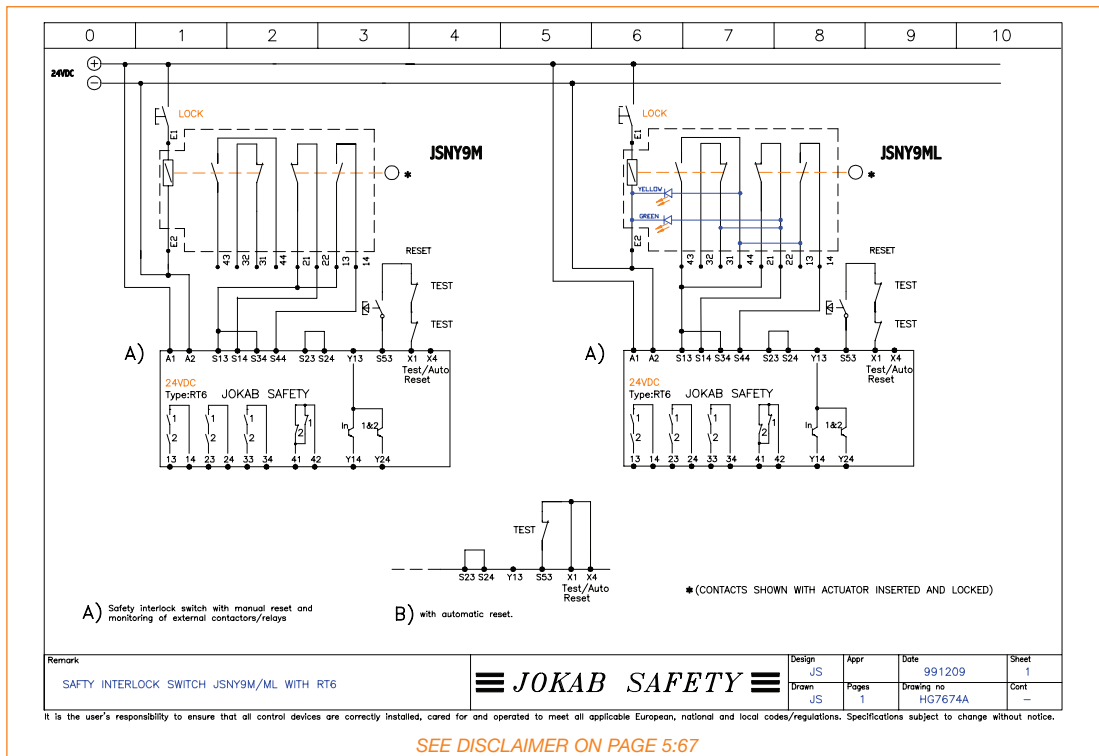

Example with Interlocked Doors/Switches

HG7674B Safety Interlock Switch JSNY9S/SLA with RT6

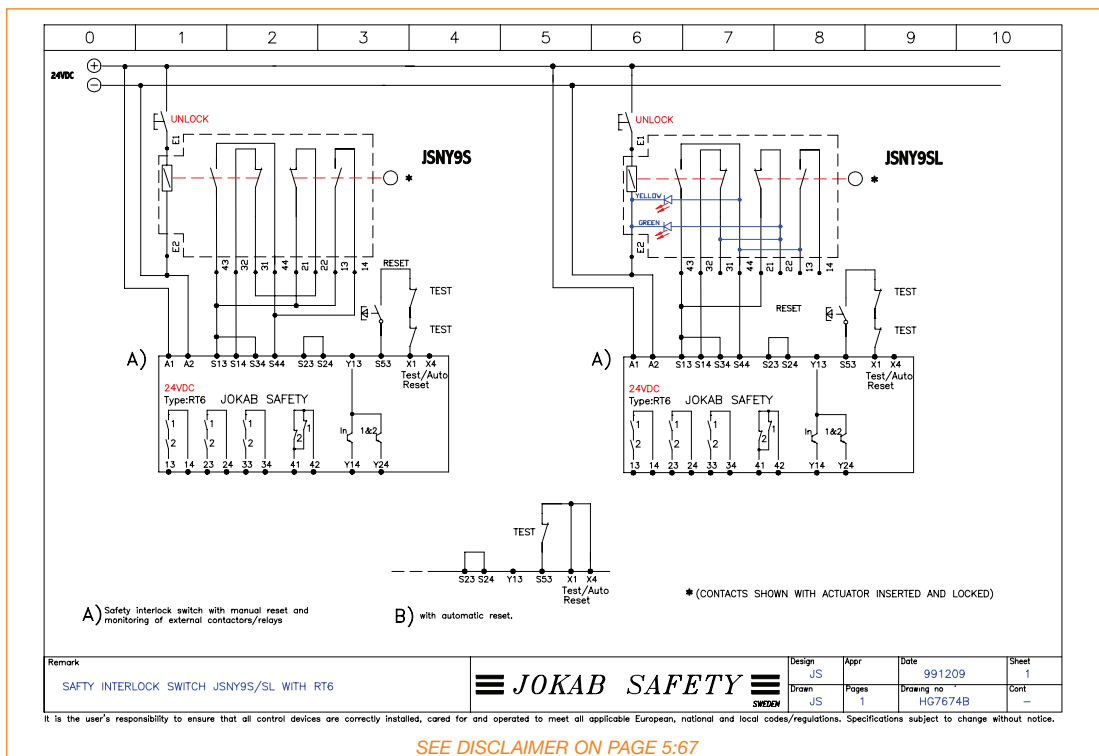

Additional Example

HH000C Three-Position Device JSHD4 with Various Safety Modules

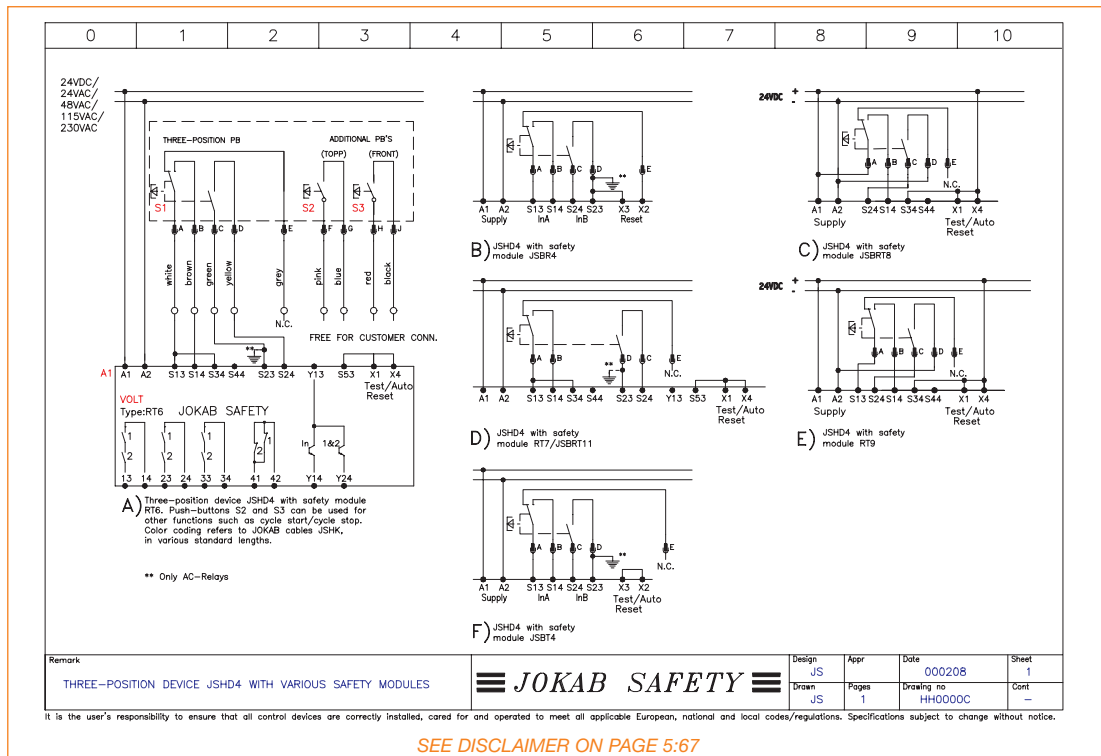

Additional Example

HI852A Connection Example JSHT2 Intermittent Running

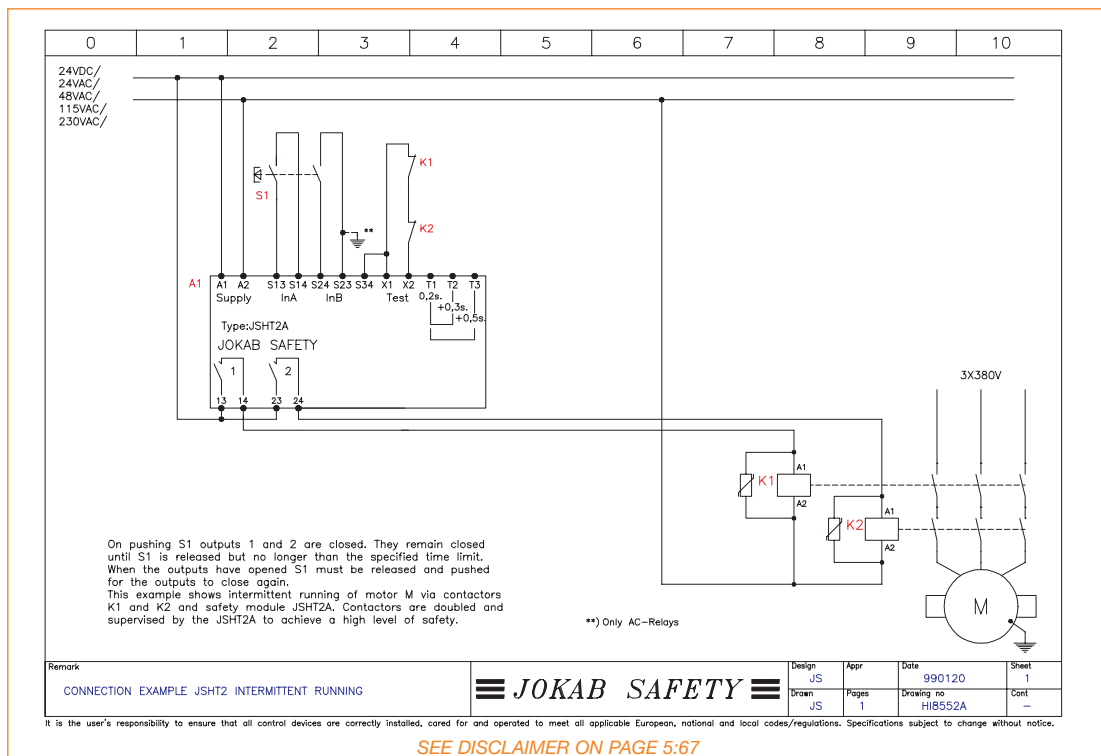

Example with Safety Mats and Contact Strips

HK7600A Safety Mat/Contact Strip with RT6

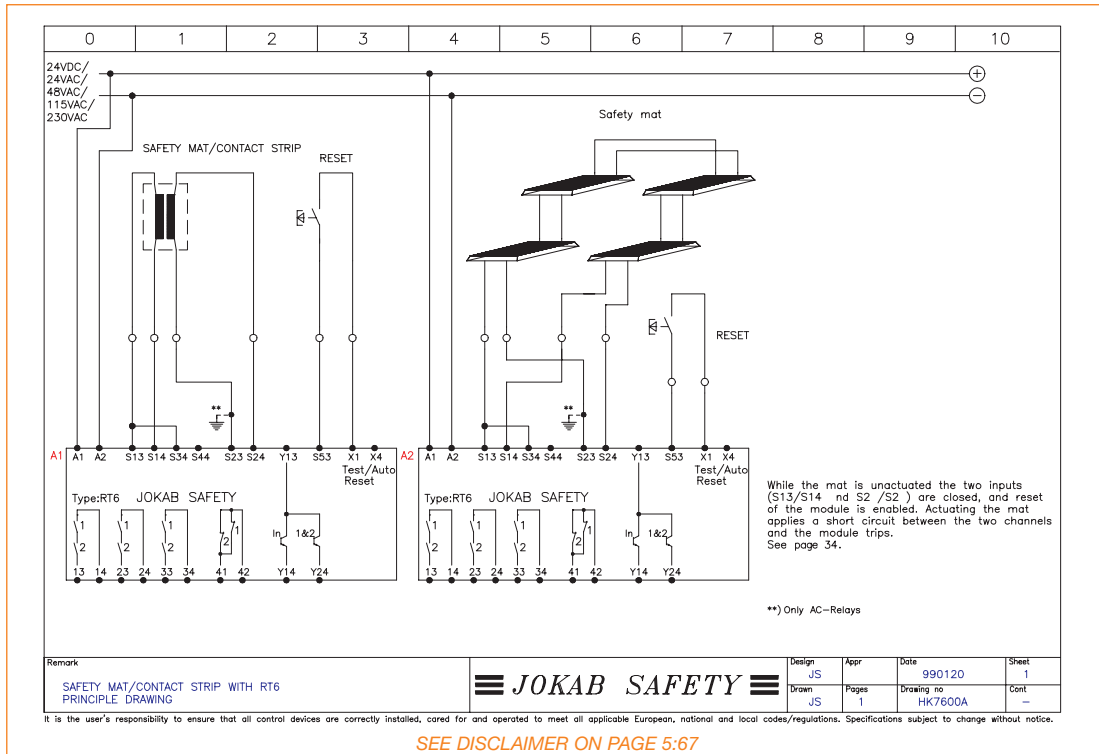

Example with Hatches

HL7600B Several JSNY7 connected to one RT6 with Unique Indication

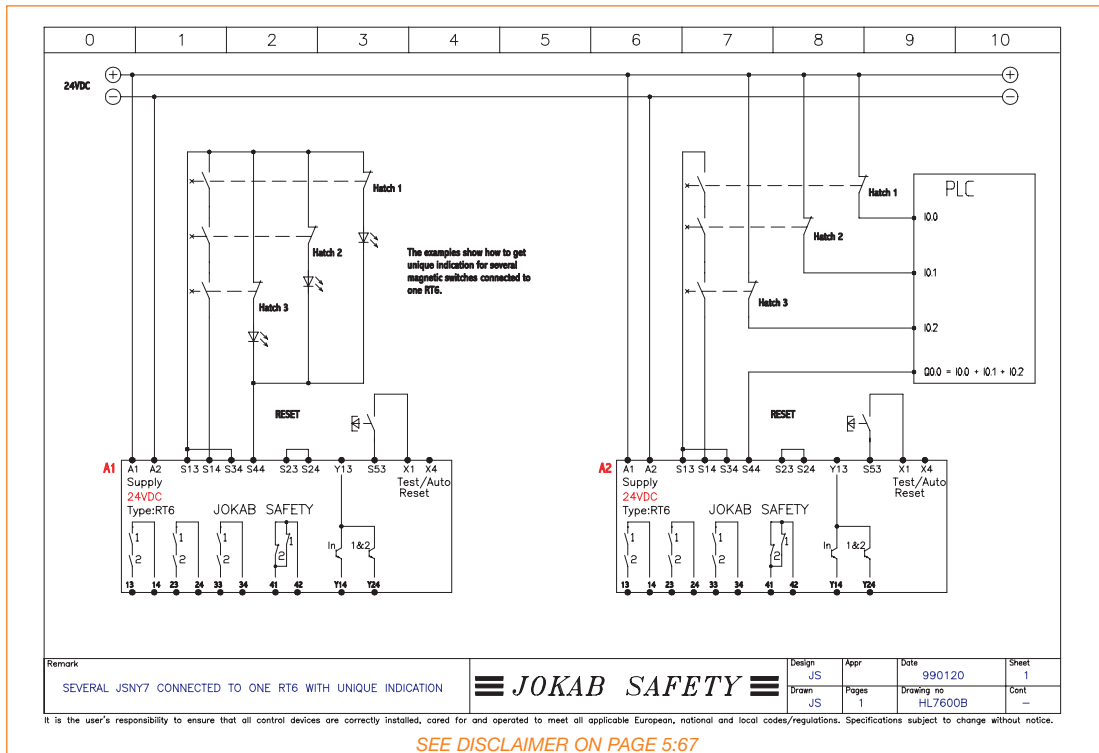

Example with Magnetic Switches

HM0000A Magnetic Switch JSNY7 with Various Safety Modules

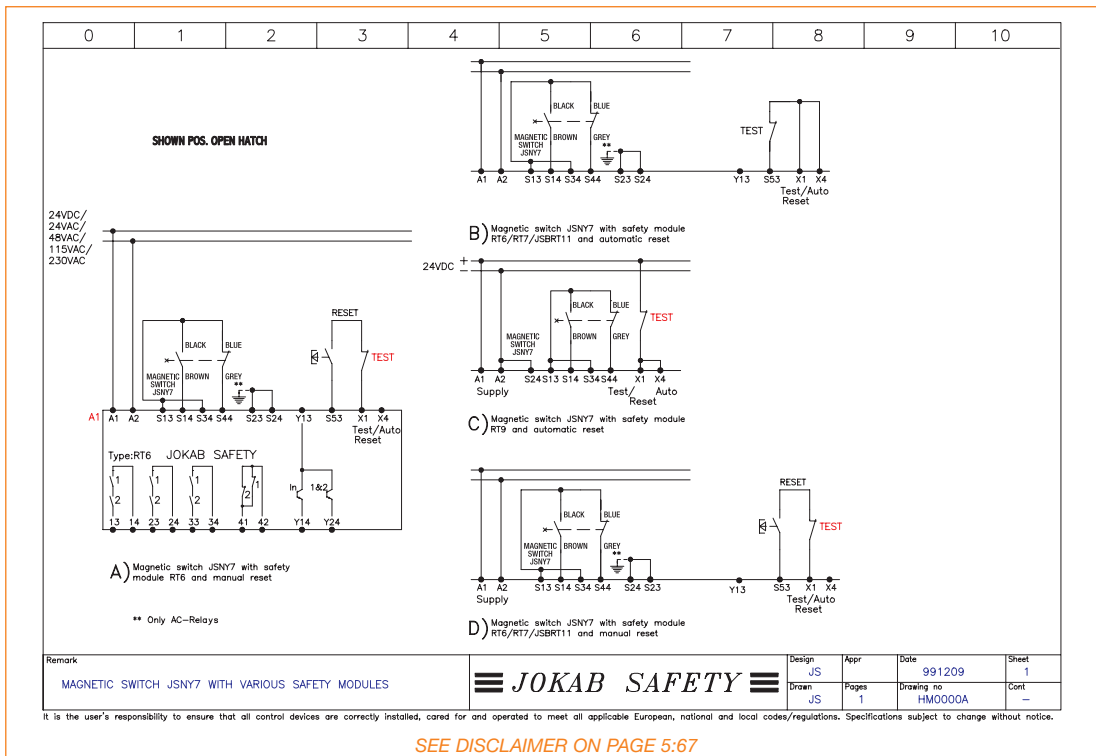

Output Example

HN7660A Delayed Outputs RT6 with Output Expansion JSR3T/RT7

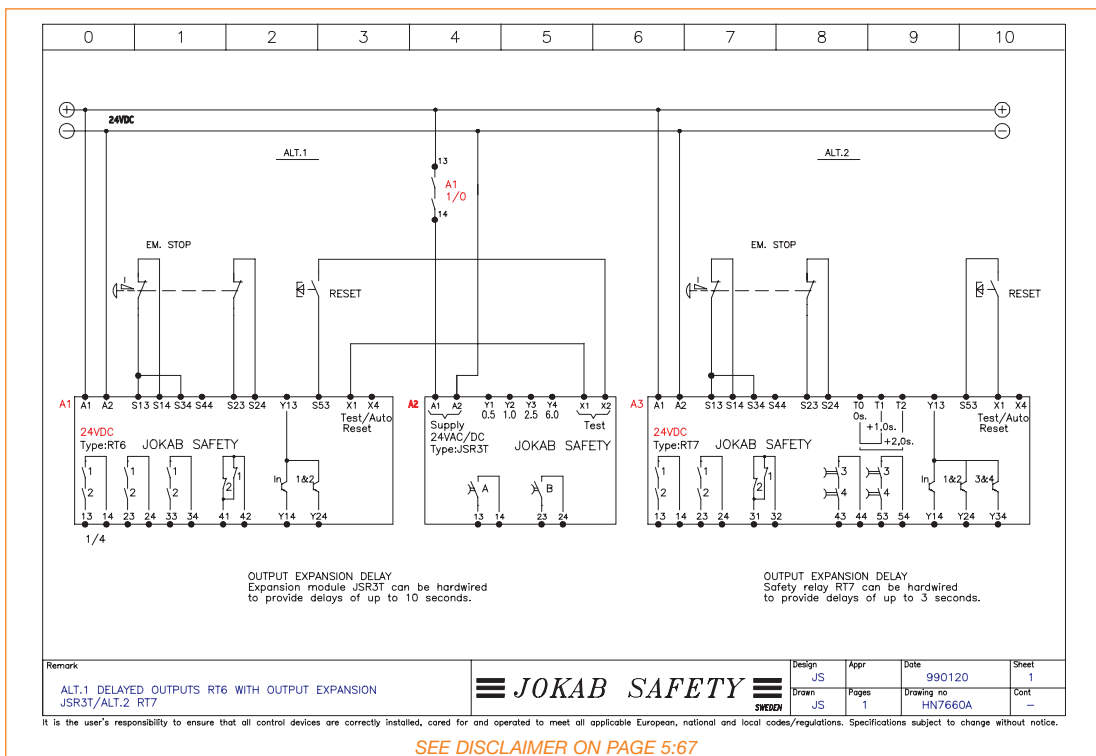

Common Example

HP7600A Machine Control - Isolation of PLC Inputs and Outputs

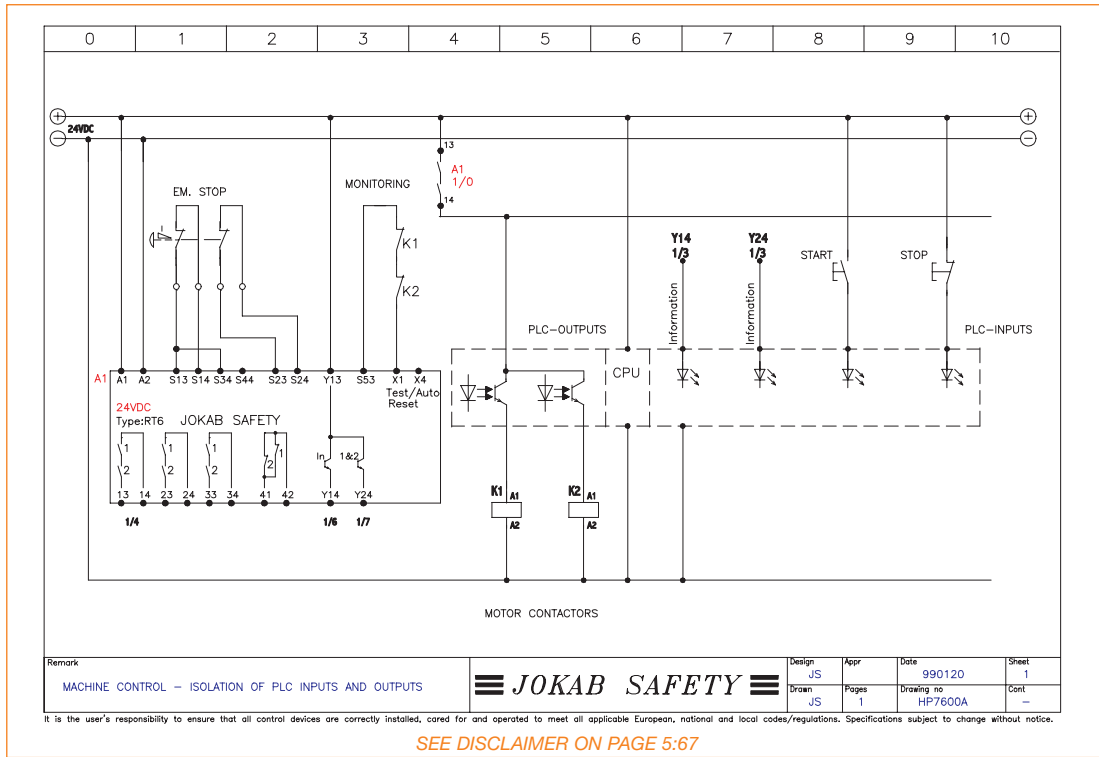

Common Example

HP7600B Machine Control - Isolation of PLC Outputs

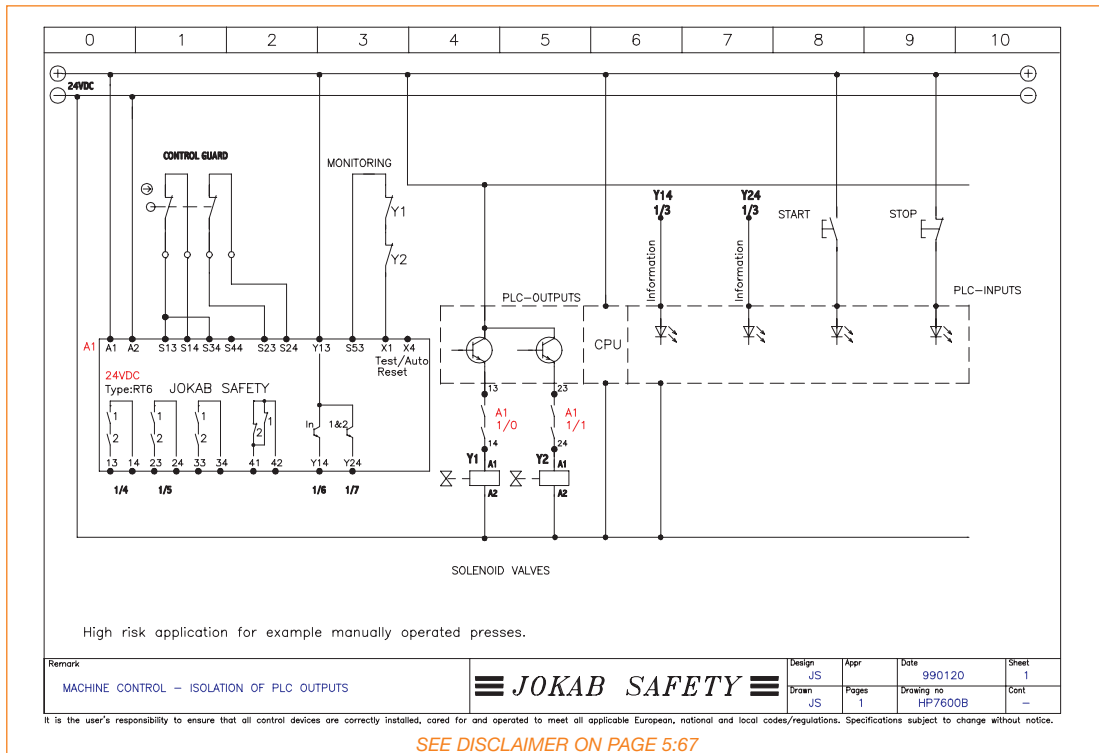





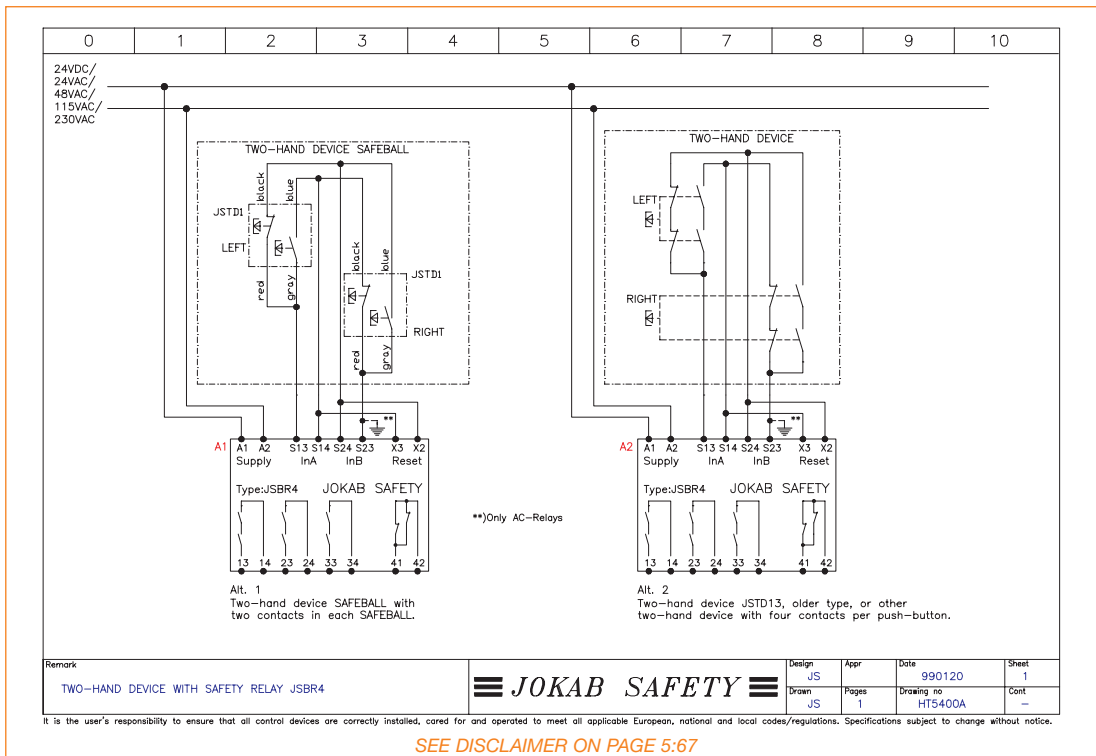



Example with Two-Hand Device



HT5400A Two-Hand Device with JSBR4







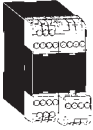
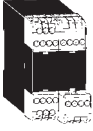

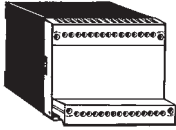
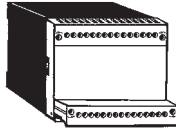
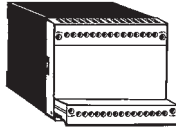
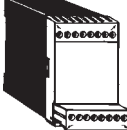
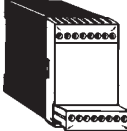
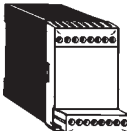

Component List - Safety Relays

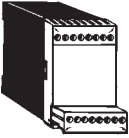
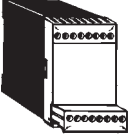
Designation		Ordering Information	Description
RT6 24VDC		2TLA010026R0000	Safety relay with 3 safety outputs, 5 selectable input options (single or dual channel), automatic or manual supervised reset, test input for monitoring of external positive guided relays/contactors, 5 LED indicators, 1 NC information output and 2 potential free transistor information outputs, quick release terminal blocks, 45mm wide, 24VDC supply. Meets safety category 1 to 4.
RT6 24VAC		2TLA010026R0200	Safety relay with 3 safety outputs, 5 selectable input options (single or dual channel), automatic or manual supervised reset, test input for monitoring of external positive guided relays/contactors, 5 LED indicators, 1 NC information output and 2 potential free transistor information outputs, quick release terminal blocks, 45mm wide, 24VAC supply. Meets safety category 1 to 4.
RT6 115VAC		2TLA010026R0400	Safety relay with 3 safety outputs, 5 selectable input options (single or dual channel), automatic or manual supervised reset, test input for monitoring of external positive guided relays/contactors, 5 LED indicators, 1 NC information output and 2 potential free transistor information outputs, quick release terminal blocks, 45mm wide, 115VAC supply. Meets safety category 1 to 4.
RT6 230VAC		2TLA010026R0500	Safety relay with 3 safety outputs, 5 selectable input options (single or dual channel), automatic or manual supervised reset, test input for monitoring of external positive guided relays/contactors, 5 LED indicators, 1 NC information output and 2 potential free transistor information outputs, quick release terminal blocks, 45mm wide, 230VAC supply. Meets safety category 1 to 4.
RT7 A 24VDC		2TLA010028R2000	Safety relay with 4 safety outputs (2 outputs can be off-delayed by 0, 0.5, 1 or 1.5 seconds via hardwire jumpers), 5 selectable input options (single or dual channel), automatic or manual supervised reset, test input for monitoring of external positive guided relays/contactors, 6 LED indicators, 1 NC information output and 3 potential free transistor information outputs, quick release terminal blocks, 45mm wide, 24VDC supply. Meets safety category 1 to 4.
RT7 A 115VAC		2TLA010028R2400	Safety relay with 4 safety outputs (2 outputs can be off-delayed by 0, 0.5, 1 or 1.5 seconds via hardwire jumpers), 5 selectable input options (single or dual channel), automatic or manual supervised reset, test input for monitoring of external positive guided relays/contactors, 6 LED indicators, 1 NC information output and 3 potential free transistor information outputs, quick release terminal blocks, 45mm wide, 115VAC supply. Meets safety category 1 to 4.
RT7 A 230VAC		2TLA010028R2500	Safety relay with 4 safety outputs (2 outputs can be off-delayed by 0, 0.5, 1 or 1.5 seconds via hardwire jumpers), 5 selectable input options (single or dual channel), automatic or manual supervised reset, test input for monitoring of external positive guided relays/contactors, 6 LED indicators, 1 NC information output and 3 potential free transistor information outputs, quick release terminal blocks, 45mm wide, 230VAC supply. Meets safety category 1 to 4.
RT7 B 24VDC		2TLA010028R1000	Safety relay with 4 safety outputs (2 outputs can be off-delayed by 0, 1, 2 or 3 seconds via hardwire jumpers), 5 selectable input options (single or dual channel), automatic or manual supervised reset, test input for monitoring of external positive guided relays/contactors, 6 LED indicators, 1 NC information output and 3 potential free transistor information outputs, quick release terminal blocks, 45mm wide, 24VDC supply. Meets safety category 1 to 4.





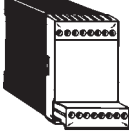

Component List - Safety Relays

Designation		Ordering Information	Description
RT7 B 115VAC		2TLA010028R1400	Safety relay with 4 safety outputs (2 outputs can be off-delayed by 0, 1, 2 or 3 seconds via hardwire jumpers), 5 selectable input options (single or dual channel), automatic or manual supervised reset, test input for monitoring of external positive guided relays/contactors, 6 LED indicators, 1 NC information output and 3 potential free transistor information outputs, quick release terminal blocks, 45mm wide, 115VAC supply. Meets safety category 1 to 4.
RT7 B 230VAC		2TLA010028R1500	Safety relay with 4 safety outputs (2 outputs can be off-delayed by 0, 1, 2 or 3 seconds via hardwire jumpers), 5 selectable input options (single or dual channel), automatic or manual supervised reset, test input for monitoring of external positive guided relays/contactors, 6 LED indicators, 1 NC information output and 3 potential free transistor information outputs, quick release terminal blocks, 45mm wide, 230VAC supply. Meets safety category 1 to 4.
RT9 24VDC		2TLA010029R0000	Safety relay with 2 safety outputs, 5 selectable input options (single or dual channel), automatic or manual supervised reset, test input for monitoring of external positive guided relays/contactors, 5 LED indicators, 1 dual purpose information output, quick release terminal blocks, 22.5mm wide, 24VDC supply. Meets safety category 1 to 4.
JSBRT11 24VDC		2TLA010025R0000	Safety relay with 7 safety outputs, 4 selectable input options (single or dual channel), automatic or manual supervised reset, test input for monitoring of external positive guided relays/contactors, 5 LED indicators, 2 NC information outputs, quick release terminal blocks, 100mm wide, 24VDC supply. Meets safety category 1 to 4.
JSBRT11 115VAC		2TLA010025R0400	Safety relay with 7 safety outputs, 4 selectable input options (single or dual channel), automatic or manual supervised reset, test input for monitoring of external positive guided relays/contactors, 5 LED indicators, 2 NC information outputs, quick release terminal blocks, 100mm wide, 115VAC supply. Meets safety category 1 to 4.
JSBRT11 230VAC		2TLA010025R0500	Safety relay with 7 safety outputs, 4 selectable input options (single or dual channel), automatic or manual supervised reset, test input for monitoring of external positive guided relays/contactors, 5 LED indicators, 2 NC information outputs, quick release terminal blocks, 100mm wide, 230VAC supply. Meets safety category 1 to 4.
JSBR4 24VDC		2TLA010002R0000	Safety relay with 3 safety outputs, dual channel and two-hand device monitoring, manual supervised reset, test input for monitoring of external positive guided relays/contactors, 3 LED indicators, 1 NC information output, quick release terminal blocks, 45mm wide, 24VDC supply. Meets safety category 4. Dual input channel synchronism 0.5s.
JSBR4 24VAC		2TLA010002R0200	Safety relay with 3 safety outputs, dual channel and two-hand device monitoring, manual supervised reset, test input for monitoring of external positive guided relays/contactors, 3 LED indicators, 1 NC information output, quick release terminal blocks, 45mm wide, 24VAC supply. Meets safety category 4. Dual input channel synchronism 0.5s.
JSBR4 115VAC		2TLA010002R0400	Safety relay with 3 safety outputs, dual channel and two-hand device monitoring, manual supervised reset, test input for monitoring of external positive guided relays/contactors, 3 LED indicators, 1 NC information output, quick release terminal blocks, 45mm wide, 115VAC supply. Meets safety category 4. Dual input channel synchronism 0.5s.

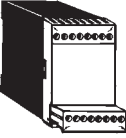
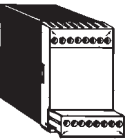
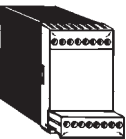
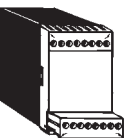
Component List - Safety Relays

Designation		Ordering Information	Description
JSBR4 230VAC		2TLA010002R0500	Safety relay with 3 safety outputs, dual channel and two-hand device monitoring, manual supervised reset, test input for monitoring of external positive guided relays/contactors, 3 LED indicators, 1 NC information output, quick release terminal blocks, 45mm wide, 230VAC supply. Meets safety category 4. Dual input channel synchronism 0.5s.
JSBT4 24VDC		2TLA010004R0000	Safety relay with 3 safety outputs, dual channel, automatic reset, test input for monitoring of external positive guided relays/contactors, 3 LED indicators, 1 NC information output, quick release terminal blocks, 45mm wide, 24VDC supply. Meets safety category 4. Dual input channel synchronism 0.5s.
BT50 24VDC		2TLA010033R0000	Safety relay with 3 safety outputs, 1 NC status output, 2 selectable input options (single or dual channel), manual supervised reset, test input for monitoring of external positive guided relays/contactors, 3 LED indicators, quick release terminal blocks, 22.5 mm wide, 24VDC supply.
BT50T 24VDC		2TLA010033R1000	Safety relay with 3 safety outputs, 1 NC status output, 2 selectable input options (single or dual channel), manual supervised reset, test input for monitoring of external positive guided relays/contactors, 3 LED indicators, quick release terminal blocks, 22.5mm wide, 24VDC supply. Output delay times hardwire selectable between 0s, 0.5s, 1s or 1.5s.
BT51 24VDC		2TLA010033R2000	Safety relay with 4 safety outputs, 2 selectable input options (single or dual channel), manual supervised reset, test input for monitoring of external positive guided relays/contactors, 3 LED indicators, quick release terminal blocks, 22.5mm wide, 24VDC supply.
BT51T 24VDC		2TLA010033R3000	Safety relay with 4 safety outputs, 2 selectable input options (single or dual channel), manual supervised reset, test input for monitoring of external positive guided relays/contactors, 3 LED indicators, quick release terminal blocks, 22.5mm wide, 24 VDC supply. Output delay times hardwire selectable between 0s, 0.5s, 1s or 1.5s.
JSBT5 24VDC/AC		2TLA010005R0100	Safety timer relay with 3 NO outputs, selectable single or dual channel, test input for monitoring of external positive guided relays or contactors, 1 LED indicator, 22.5mm wide, 24VDC/AC supply. Meets safety category 1 to 4.
JSBT5 12VDC		2TLA010005R0700	Safety timer relay with 3 NO outputs, selectable single or dual channel, test input for monitoring of external positive guided relays or contactors, 1 LED indicator, 22.5mm wide, 12VDC supply. Meets safety category 1 to 4.
JSBT5T 24VDC/AC		2TLA010005R1100	Safety timer relay with 3 NO outputs, 500ms delayed, selectable single or dual channel, test input for monitoring of external positive guided relays or contactors, 1 LED indicator, 22.5mm wide, 24VDC/AC supply. Meets safety category 1 to 4.
JSHT1A 24VDC		2TLA010011R0000	Safety timer relay with 2 single NO outputs (hardwire time selection of 5, 10, 15 or 20 seconds timing function), selectable single or dual channel, test input for monitoring of external positive guided relays or contactors, 3 LED indicators, 45mm wide, 24VDC supply. Meets safety category 1 to 4. Quick release terminal blocks.

Component List - Safety Relays

Designation		Ordering Information	Description
JSHT1B 24VDC		2TLA010011R1000	Safety timer relay with 2 single NO outputs (hardwire time selection of 5, 15, 30 or 40 seconds timing function), selectable single or dual channel, test input for monitoring of external positive guided relays or contactors, 3 LED indicators, 45mm wide, 24VDC supply. Meets safety category 1 to 4. Quick release terminal blocks.
JSHT2A 24VDC		2TLA010012R0000	Safety timer relay with 2 single NO outputs (hardwire time selection of 0.2, 0.5, 0.7 or 1 seconds timing function), selectable single or dual channel, test input for monitoring of external positive guided relays or contactors, 3 LED indicators, 45mm wide, 24VDC supply. Meets safety category 1 to 4. Quick release terminal blocks.
JSHT2B 24VDC		2TLA010012R1000	Safety timer relay with 2 single NO outputs (hardwire time selection of 5, 10, 15 or 20 seconds timing function), selectable single or dual channel, test input for monitoring of external positive guided relays or contactors, 3 LED indicators, 45mm wide, 24VDC supply. Meets safety category 1 to 4. Quick release terminal blocks.
JSHT2C 24VDC		2TLA010012R2000	Safety timer relay with 2 single NO outputs (hardwire time selection of 5, 15, 30 or 40 seconds timing function), selectable single or dual channel, test input for monitoring of external positive guided relays or contactors, 3 LED indicators, 45mm wide, 24VDC supply. Meets safety category 1 to 4. Quick release terminal blocks.
E1T 0s		2TLA010030R0000	Expansion relay with 4 safety outputs for expansion of safety relay, single or dual channel connection, 2 LED indicators, quick release terminal blocks, 22.5mm wide, 24VDC supply. Meets safety category 1 to 4.
E1T 0.5s		2TLA010030R1000	Expansion relay with 4 safety outputs (off-delayed by 500ms.) for expansion of safety relay, single or dual channel connection, 2 LED indicators, quick release terminal blocks, 22.5mm wide, 24VDC supply. Meets safety category 1 to 4.
E1T 1s		2TLA010030R2000	Expansion relay with 4 safety outputs (off-delayed by 1s.) for expansion of safety relay, single or dual channel connection, 2 LED indicators, quick release terminal blocks, 22.5mm wide, 24VDC supply. Meets safety category 1 to 4.
E1T 1.5s		2TLA010030R3000	Expansion relay with 4 safety outputs (off-delayed by 1.5s.) for expansion of safety relay, single or dual channel connection, 2 LED indicators, quick release terminal blocks, 22.5mm wide, 24VDC supply. Meets safety category 1 to 4.
E1T 2s		2TLA010030R4000	Expansion relay with 4 safety outputs (off-delayed by 2s.) for expansion of safety relay, single or dual channel connection, 2 LED indicators, quick release terminal blocks, 22.5mm wide, 24VDC supply. Meets safety category 1 to 4.
E1T 3s		2TLA010030R5000	Expansion relay with 4 safety outputs (off-delayed by 3s.) for expansion of safety relay, single or dual channel connection, 2 LED indicators, quick release terminal blocks, 22.5mm wide, 24VDC supply. Meets safety category 1 to 4.

Component List - Safety Relays

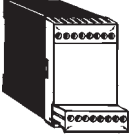
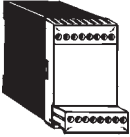
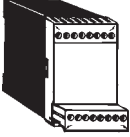
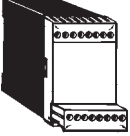
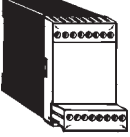
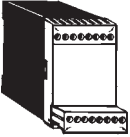
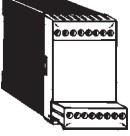
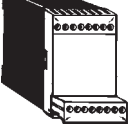
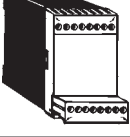
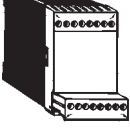
Designation	Ordering Information	Description
JSR1T 0s	 2TLA010015R0000	Expansion relay with 4 safety outputs for expansion of safety relay, single or dual channel connection, 2 LED indicators, 1 NC information output, quick release terminal blocks, 45mm wide, 24VDC supply. Meets safety category 1 to 4.
JSR1T 0.5s	 2TLA010015R1000	Expansion relay with 4 safety outputs (off-delayed by 500ms.) for expansion of safety relay, single or dual channel connection, 2 LED indicators, 1 NC information output, quick release terminal blocks, 45mm wide, 24VDC supply. Meets safety category 1 to 4.
JSR1T 1s	 2TLA010015R3000	Expansion relay with 4 safety outputs (off-delayed by 1s.) for expansion of safety relay, single or dual channel connection, 2 LED indicators, 1 NC information output, quick release terminal blocks, 45mm wide, 24VDC supply. Meets safety category 1 to 4.
JSR1T 1.5s	 2TLA010015R0500	Expansion relay with 4 safety outputs (off-delayed by 1.5s.) for expansion of safety relay, single or dual channel connection, 2 LED indicators, 1 NC information output, quick release terminal blocks, 45mm wide, 24VDC supply. Meets safety category 1 to 4.
JSR1T 2s	 2TLA010015R4000	Expansion relay with 4 safety outputs (off-delayed by 2s.) for expansion of safety relay, single or dual channel connection, 2 LED indicators, 1 NC information output, quick release terminal blocks, 45mm wide, 24VDC supply. Meets safety category 1 to 4.
JSR1T 3s	 2TLA010015R5000	Expansion relay with 4 safety outputs (off-delayed by 3s.) for expansion of safety relay, single or dual channel connection, 2 LED indicators, 1 NC information output, quick release terminal blocks, 45mm wide, 24VDC supply. Meets safety category 1 to 4.
JSR1T 5s	 2TLA010015R6000	Expansion relay with 4 safety outputs (off-delayed by 5s.) for expansion of safety relay, single or dual channel connection, 2 LED indicators, 1 NC information output, quick release terminal blocks, 45mm wide, 24VDC supply. Meets safety category 1 to 4.
JSR1T 8s	 2TLA010015R0600	Expansion relay with 4 safety outputs (off-delayed by 8s.) for expansion of safety relay, single or dual channel connection, 2 LED indicators, 1 NC information output, quick release terminal blocks, 45mm wide, 24VDC supply. Meets safety category 1 to 4.
JSR1T 10s	 2TLA010015R2000	Expansion relay with 4 safety outputs (off-delayed by 10s.) for expansion of safety relay, single or dual channel connection, 2 LED indicators, 1 NC information output, quick release terminal blocks, 45mm wide, 24VDC supply. Meets safety category 1 to 4.
JSR2A 10A 24VDC/AC	 2TLA010027R0100	Expansion relay with 4 safety outputs (10A/250V maximum rating) for expansion of safety relay, single or dual channel connection, 3 LED indicators, 1 NC information output, quick release terminal blocks, 45mm wide, 24VDC/AC supply. Meets safety category 1 to 4.

Component List - Safety Relays

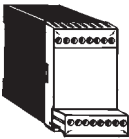
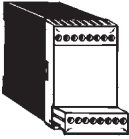
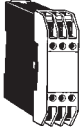
Designation		Ordering Information	Description
JSR2A 10A 115VAC		2TLA010027R0400	Expansion relay with 4 safety outputs (10A/250V maximum rating) for expansion of safety relay, single or dual channel connection, 3 LED indicators, 1 NC information output, quick release terminal blocks, 45mm wide, 115VAC supply. Meets safety category 1 to 4.
JSR2A 10A 230VAC		2TLA010027R0500	Expansion relay with 4 safety outputs (10A/250V maximum rating) for expansion of safety relay, single or dual channel connection, 3 LED indicators, 1 NC information output, quick release terminal blocks, 45mm wide, 230VAC supply. Meets safety category 1 to 4.
JSR3T 24VAC/DC		2TLA010017R0100	Expansion relay with 2 single NO outputs (hardwire selectable off-delay of 500ms. to 10s.) for expansion of safety relay, single or dual channel connection, 1 LED indicator, 22.5mm wide, 24VAC/DC supply. Meets safety category 1 to 4.

This document and any attachments may include suggested specifications, drawings, schematics and similar materials from ABB Inc. Use of such information and/or documentation by the recipient is subject to and conditioned upon your acceptance of the terms of the General Document Disclaimer which can be found at www.jokabsafetyna.com. Your acceptance of the terms of such General Document Disclaimer is conclusively presumed unless you notify ABB in writing of your disagreement with the terms of such Disclaimer immediately upon receipt of this document and you return to ABB all specifications, drawings, schematics and similar materials provided to you by ABB.